

WAT-2400S & WAT-933 User Manual

Rev. 3.2.1

Waterc Co., Ltd.

Revision Record

Rev.	Date	Changes
1.0.0	September 1, 2018	-
2.0.0	April 1, 2019	Upgrade to F/W 2.0.0 <ul style="list-style-type: none"> • Updated the 6.3.2.Exposure <ul style="list-style-type: none"> • Added the Anti Saturation • Added the AE Speed • Added the AGC MIN • Updated the 6.3.3.Backlight <ul style="list-style-type: none"> • Added the BLC OSD ON • Updated the 6.4.1.Video <ul style="list-style-type: none"> • Added the CVBR of the Bitrate Control • Updated the 6.5.1.Ethernet <ul style="list-style-type: none"> • Added Note of the FTP Server • Updated the 6.6.1.Info <ul style="list-style-type: none"> • Added Note of the Continuous Recording • Added the 6.6.2.Schedule • Added the 6.6.3.Timelapse
2.0.1	June 5, 2019	Upgrade to F/W 2.0.4 <ul style="list-style-type: none"> • Updated the 6.4.1.Video <ul style="list-style-type: none"> • Added the Authenticate streaming
2.0.2	September 1, 2019	Upgrade to F/W 2.0.5 <ul style="list-style-type: none"> • Updated the 6.6.1.Info <ul style="list-style-type: none"> • Added the Operation when SD-Card is full
2.0.3	July 31, 2020	Upgrade to F/W 2.1.1 <ul style="list-style-type: none"> • Updated the 6.1.How to access the setting page <ul style="list-style-type: none"> • Change the description of default password • Updated the 6.2.1.User Information <ul style="list-style-type: none"> • Change the description of Password, Confirm • Updated the 6.4.1.Video <ul style="list-style-type: none"> • Added the HTTP&ONVIF Port • Change the description of Authenticate streaming • Updated the 6.5.1.Ethernet <ul style="list-style-type: none"> • Added the Ethernet MTU

		<ul style="list-style-type: none"> • Updated the 6.6.1.Info <ul style="list-style-type: none"> • Added the Save log • Added the 7.2.1.Enable the FTP Server
2.0.4	October 20, 2020	<ul style="list-style-type: none"> • Updated the 6.1.How to access the setting page <ul style="list-style-type: none"> • Change the description of default password • Updated the 6.2.1.User Information <ul style="list-style-type: none"> • Change the description of Password, Confirm • Updated the 7.1. How to use ONVIF Device Manager <ul style="list-style-type: none"> • Change the description of Password • Updated the 7.2.2.A case of FileZilla <ul style="list-style-type: none"> • Change the description of Password
2.0.5	December 23, 2020	<ul style="list-style-type: none"> • Added the 1.1.Precautions when using microSD card • Added the 1.2. microSD card format • Added the 1.3. microSD card recognition check
3.0.0	April 1, 2022	<p>Upgrade to F/W 3.0.0</p> <ul style="list-style-type: none"> • Updated the 6.1.1.Overview <ul style="list-style-type: none"> • Change the figure and description of items • Updated the 6.2.1.User Information <ul style="list-style-type: none"> • Change the figure • Added the New ID and the New Password • Updated the 6.2.2.Date & Time <ul style="list-style-type: none"> • Change the figure and description of items • Updated the 6.2.3. Firmware Update <ul style="list-style-type: none"> • Change the figure • Updated the 6.3.1.IRIS <ul style="list-style-type: none"> • Added Notes • Updated the 6.3.2.Exposure <ul style="list-style-type: none"> • Change the figure and description of items • Updated the 6.3.3. Backlight <ul style="list-style-type: none"> • Change the figure and description of items • Updated the 6.3.4.Color <ul style="list-style-type: none"> • Change the figure and description of items • Updated the 6.3.5.Picture <ul style="list-style-type: none"> • Change the figure and description of items

		<ul style="list-style-type: none"> • Added AUTO DAY and AUTO NIGHT • Deleted the Privacy Mask • Added the 6.3.6. Privacy • Updated the 6.3.7. Motion <ul style="list-style-type: none"> • Change the figure and description of items • Updated the 6.3.8. Output Set <ul style="list-style-type: none"> • Change the figure and description of items • Updated the 6.3.9. System <ul style="list-style-type: none"> • Change the figure and description of items • Updated the 6.4.1. Video <ul style="list-style-type: none"> • Change the figure and description of items • Added the Recording time • Updated the 6.5.1. Ethernet <ul style="list-style-type: none"> • Change the figure and description of items • Updated the 6.6.1. Info <ul style="list-style-type: none"> • Change the figure and description of items • Updated the 6.6.2. Schedule <ul style="list-style-type: none"> • Change the figure and description of items • Updated the 6.6.3. Timelapse <ul style="list-style-type: none"> • Change the figure and description of items
3.1.0	July 1, 2022	<ul style="list-style-type: none"> • Updated the 6.Changing the camera settings from the Web browser <ul style="list-style-type: none"> • Change the text and added the table • Updated the 6.1.1.Overview (top page) <ul style="list-style-type: none"> • Change the text and the figure • Updated the 6.4.2.H.264 View <ul style="list-style-type: none"> • Delete the contents • Delete the 7.3. When streaming does not play on WEB setting page • Added Trademark Notice
3.1.1	August 26, 2022	<ul style="list-style-type: none"> • Updated the 6.3.4.Color <ul style="list-style-type: none"> • Change the default value of AWB, and added description
3.2.1	January 17, 2023	<ul style="list-style-type: none"> • Updated the 6.5.1.Ethernet <ul style="list-style-type: none"> • Added the Broadcast Filter

Table of Contents

1. Network connection and power activation of the camera.....	7
1.1. Precautions when using microSD card.....	8
1.2. microSD card format	9
1.3. microSD card recognition check.....	11
2. Connection of external MIC. IN	12
2.1. Corresponding terminal of external MIC. IN	12
2.2. External MIC. IN connection example	13
3. Connection of 4P cable	14
4. Network settings	15
4.1. This camera network default settings	15
4.2. Example of PC network settings.....	16
5. Checking the image from the camera.....	17
A case of VLC media player.....	17
6. Changing the camera settings from the Web browser.....	20
6.1. How to access the setting page.....	20
6.1.1. Overview (top page).....	22
6.2. SYSTEM SETUP	24
6.2.1. User Information.....	24
6.2.2. Date & Time	26
6.2.3. Firmware Update.....	29
6.2.4. Save/Load Settings.....	30
6.2.5. Reset	32
6.3. IMAGE SETUP.....	33
6.3.1. IRIS.....	33
6.3.2. Exposure	34
6.3.3. Backlight	40
6.3.4. Color.....	43
6.3.5. Picture	45
6.3.6. Privacy	48
6.3.7. Motion.....	53
6.3.8. Output Set	58
6.3.9. System	60
6.4. VIDEO SETUP	61

6.4.1.Video	61
6.4.2.H.264 View	71
6.4.3.JPEG View.....	72
6.5.NETWORK SETUP	73
6.5.1.Ethernet.....	73
6.6.SD CARD SETUP	76
6.6.1.Info.....	76
6.6.2.Schedule.....	79
6.6.3.Timelapse.....	84
6.7.How to initialize the camera setting.....	86
7.Reference	87
7.1.How to use ONVIF Device Manager.....	87
7.2.FTP Access	89
7.2.1.Enable the FTP server	89
7.2.2.A case of FileZilla	89
Trademark Notice	91

1. Network connection and power activation of the camera

The WAT-933&WAT-2400S (simply called the “camera” from now on if there is no difference in the function “WAT-933” and “WAT-2400S”.) have two power supply systems. The one is powered by +12VDC input plug on rear panel of the camera, and the other is powered by the PoE using a LAN connector. When supplying power with DC + 12 V, use an independent power supply for each camera, and do not share power with other cameras and devices.

Please supply power by either the one or the other of the way above and do not supply the both power systems simultaneously.

The below figure is a connection example of the power supply by the PoE hub. In addition, you need to have the power individually to the router and the PoE hub.

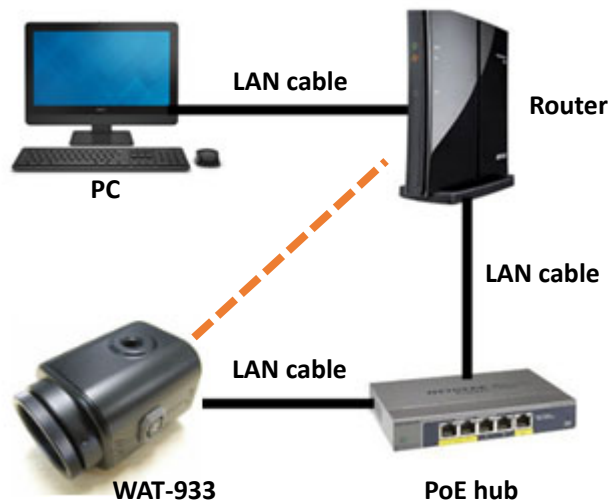

Figure 1. Network configuration example

Connect the LAN cable of camera side to the PoE port of the PoE hub and connect the LAN cable of the router side to a normal LAN port.

If you want to supply power to the camera using the AC power supplies, connect the camera and the router directly with exception of the PoE hub from the above. In a closed network configuration, the DHCP protocol and the router are not required. In that case, connect the PC and the camera directly in LAN cable.

It takes about 5 seconds to fully boot this camera from the power supply start.

1.1. Precautions when using microSD card

This camera can use a microSD card.

You can use a microSD card to recording, snapshot, time-lapse, and initialize camera settings.

For details, refer to the pages after "6.6 SD CARD SETUP".

Recommended Operating Conditions

- SDHC / SDXC standard
- MLC type or high durability model
- SD Speed Class CLASS 10 or more
- Capacity of 256GB or less

Note: The exact performance is not guaranteed for all SD cards meeting the requirement described above.

Be sure to perform a format and recognition check with the camera each time you insert a microSD card into this camera.

If you do not operate above, recording may not be performed correctly.

For the format and recognition check procedure, see "1.2. microSD card format" and "1.3. microSD card recognition check".

Note: When using a microSD card with this unit, be sure to insert / remove the card with the power turned off.

1.2. microSD card format

Be sure to format according to the following procedure each time you insert a microSD card into this camera.

Note: Please note that formatting will erase all data on the microSD card.

- I. Click "Info" on the WEB setting page to display the SD Card Information page.
Click "Format" on the SD Card Information page.

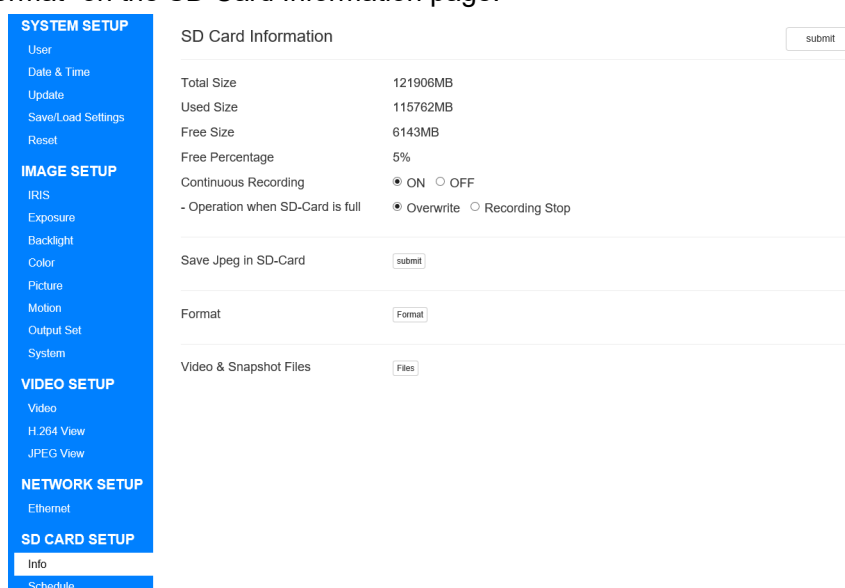

The screenshot shows the 'SD Card Information' page. On the left is a blue sidebar menu with categories: SYSTEM SETUP (User, Date & Time, Update, Save/Load Settings, Reset), IMAGE SETUP (IRIS, Exposure, Backlight, Color, Picture, Motion, Output Set, System), VIDEO SETUP (Video, H.264 View, JPEG View), NETWORK SETUP (Ethernet), and SD CARD SETUP (Info, Schedule). The 'Info' option is selected. The main content area is titled 'SD Card Information' and contains the following data:

Total Size	121906MB
Used Size	115762MB
Free Size	6143MB
Free Percentage	5%
Continuous Recording	<input checked="" type="radio"/> ON <input type="radio"/> OFF
- Operation when SD-Card is full	<input checked="" type="radio"/> Overwrite <input type="radio"/> Recording Stop

Below the table are three sections, each with a 'submit' button:

- Save Jpeg in SD-Card
- Format
- Video & Snapshot Files

Figure 2. microSD card format

- II. Click "OK" in the displayed format confirmation dialog.

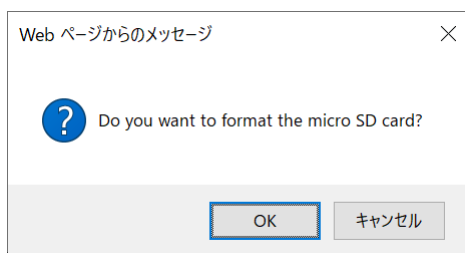

Figure 3. Format confirmation dialog

III. Please wait until the status bar reaches 100%.

When it reaches 100%, a restart confirmation dialog will be displayed. Click "OK" to restart.

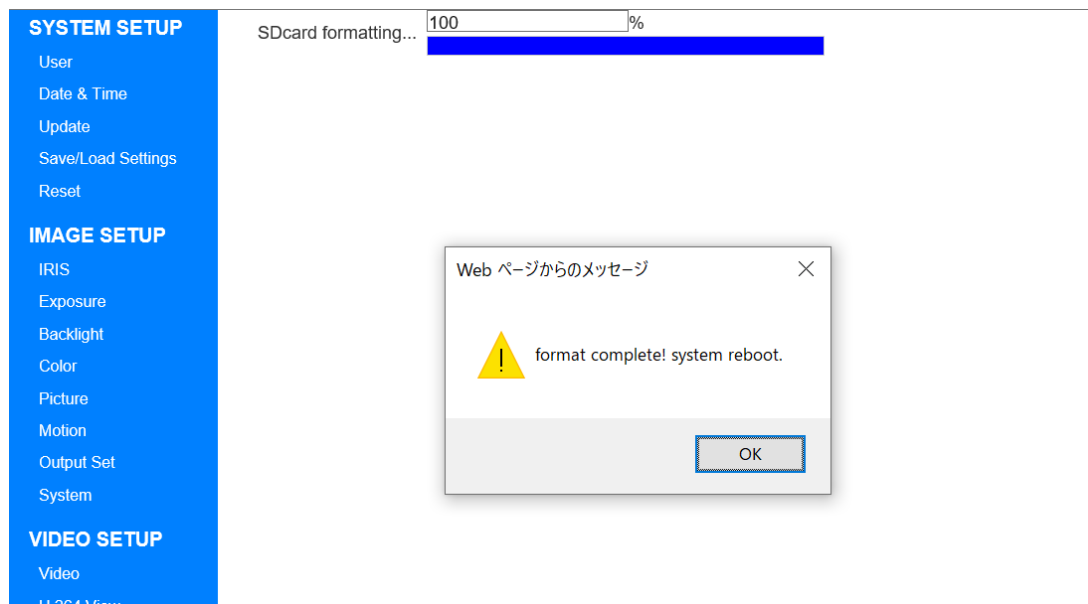

Figure 4. Status bar display and restart confirmation dialog

1.3. microSD card recognition check

When using a microSD card for recording, be sure to follow the steps below to check that the card is recognized correctly.

- I. Click Info on the WEB setting page to display the SD Card Information page.
- II. Check the Total Size and confirm that it is not 0MB.

If there is an error in the microSD card, it will be displayed as shown by the red underline in the figure below.

The screenshot shows the 'SD Card Information' page with a sidebar menu on the left. The 'Total Size' field is underlined in red. Two callout boxes are present: one labeled 'Normally' showing a successful read (Total Size: 14764MB, Used Size: 21MB, Free Size: 14742MB, Free Percentage: 99%) and one labeled 'On error' showing a failed read (Total Size: 0MB, Used Size: 0MB, Free Size: 0MB, Free Percentage: 0%).

Field	Normally	On error
Total Size	14764MB	0MB
Used Size	21MB	0MB
Free Size	14742MB	0MB
Free Percentage	99%	0%

Figure 5. Display in case of microSD card read error.

If the result of the check shows 0MB, turn off the power, insert and remove the card once, and try formatting again.

2. Connection of external MIC. IN

This camera has the MIC. IN function.

You can use the internal MIC. IN attached to the camera, and the external MIC. IN.

Refer to "6.4.1.Video" for switching the internal MIC. IN and external MIC. IN.

The connection of external MIC. IN is explained below.

2.1. Corresponding terminal of external MIC. IN

When using the external MIC. IN, please use the electret condenser microphone of TRS, TS terminal or line input of RCA terminal.

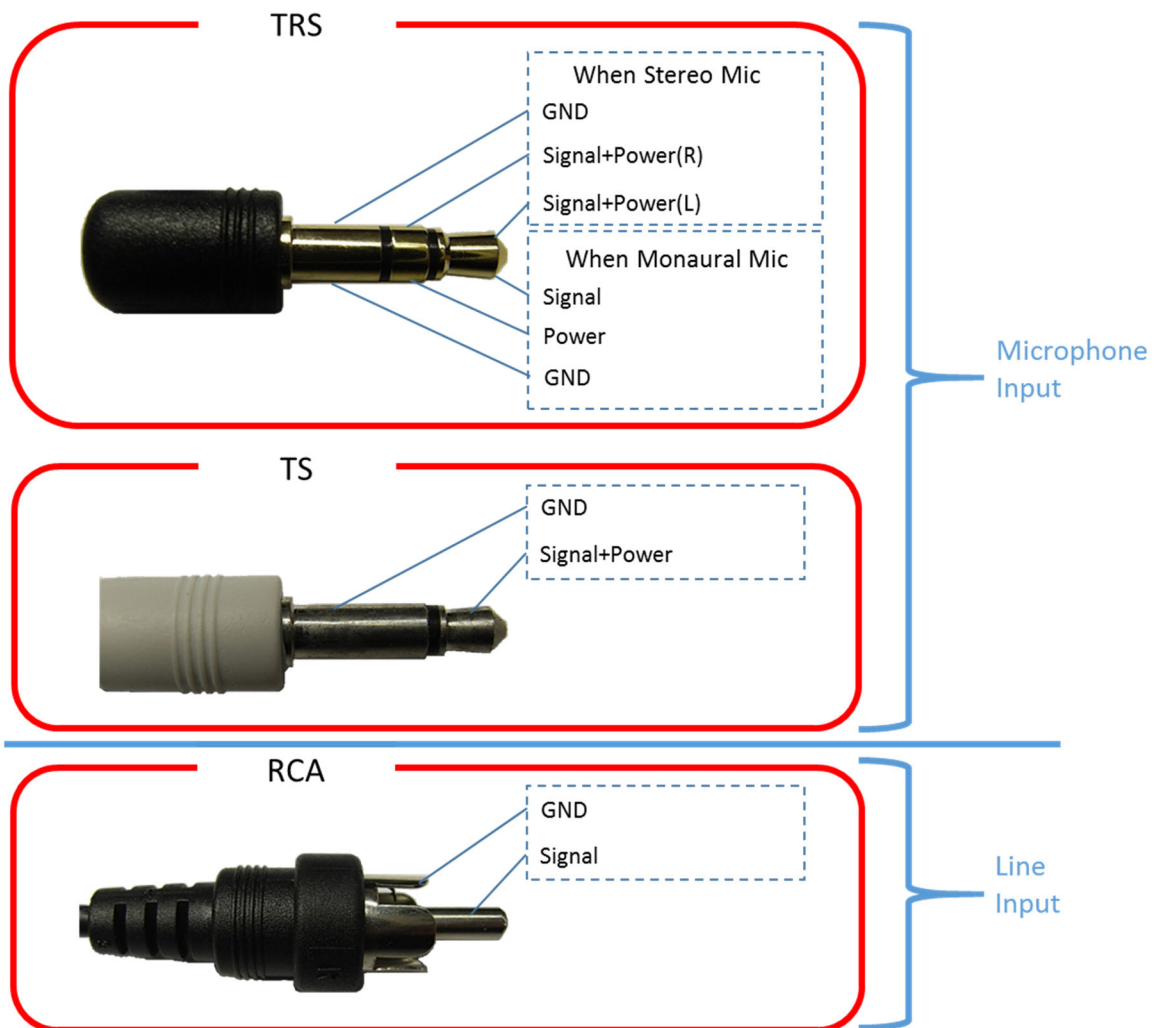
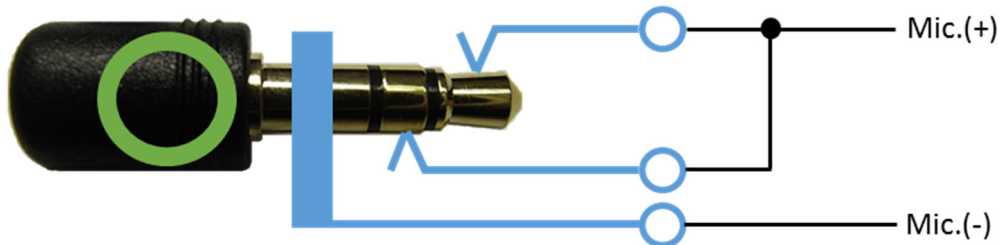

Figure 6. Corresponding terminal of external MIC. IN.

2.2. External MIC. IN connection example

Below is an example of connection of the input terminal.

When TRS (OK)



When TS (OK)

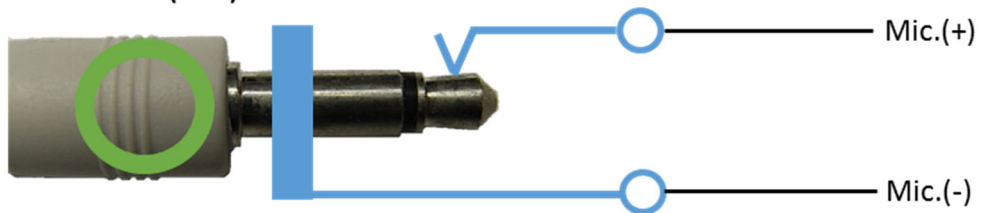

Figure 7. Correct connection example

If you connect as shown below, it will cause an accident, so please do not do it absolutely.

When TS (NG)

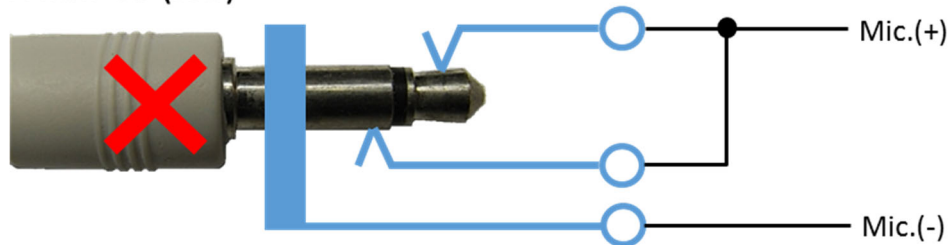

Figure 8. Wrong connection example

3. Connection of 4P cable

The wiring diagram of the included 4P cable for power supply / microphone input is as shown in the following figure.

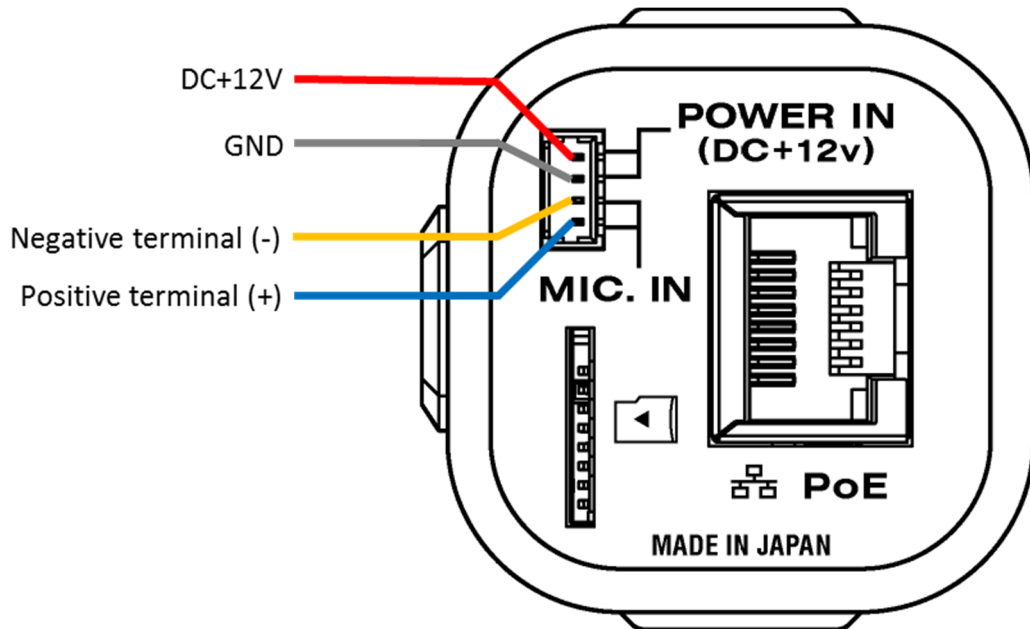

Figure 9. Wiring diagram of 4P cable

Note: Don't short circuit each terminal and the exterior case, otherwise the camera will break down.

(The negative terminal has a different potential from the power supply GND terminal.)

4. Network settings

Before using the camera, you need to configure the network.

The network initial settings and the camera setting examples are described below.

4.1. This camera network default settings

The network default setting of this camera is as follows.

Table 1. Default settings of network

IP Address	192.168.1.250 (static)
Netmask	255.255.255.0
Gateway	192.168.1.1

The network settings of this camera can be changed by the Web browser which will be described later.

It is necessary to change the network setting of the PC and the camera according to the situation.

For details on changing the network settings of the camera, refer to "6.5.1.Ethernet" below.

It is possible that the setting has been changed by this camera you used once.

In that case, please contact this camera administrator.

If you do not know the IP address you set, you can reset it to factory default settings.

Refer to "6.7. Initialization method of this camera" below.

4.2. Example of PC network settings

Connect this camera and your PC as shown in the below figure. And if the network setting of the camera is in default configuration (IP Address: 192.168.1.250 (static)), go through the following steps to set up the PC network settings.

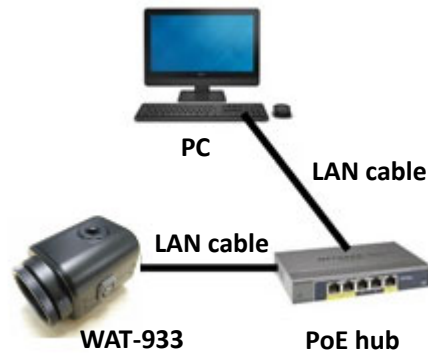

Figure 10. Minimum network configuration

Input the values as follow, click “OK” and close the property.

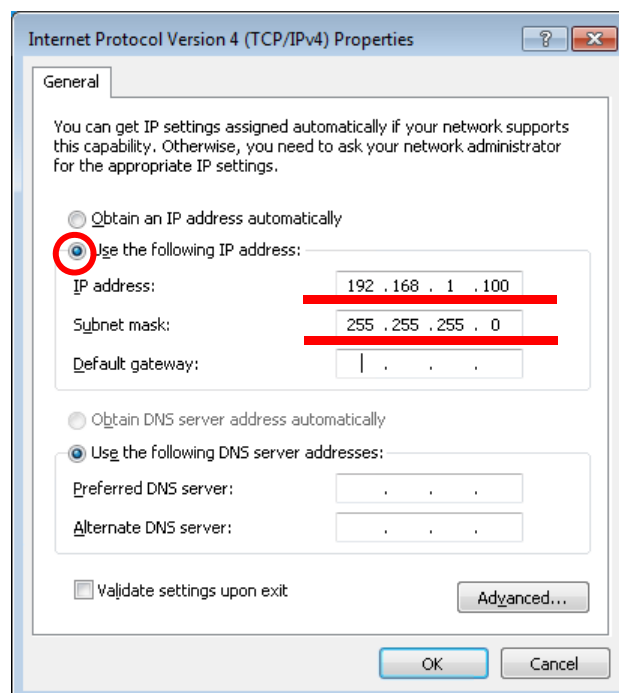

Figure 11. Internet protocol version 4 property window

5. Checking the image from the camera

You can check the video image after the network settings are completed.

This camera has the streaming format shown below.

Table 2. Streaming format

Name	Encode	Default resolution
H.264 Main	H.264	1920 * 1080
H.264 Sub		640 * 360
JPEG	MJPEG	1920 * 1080

Changes such as resolution and frame rate will be described later.

This section describes the method in the case of viewing the image from this camera using the VLC media player.

A case of VLC media player

Download the appropriate VLC which meets your PC from VideoLAN official download page (<https://www.videolan.org/vlc/index.html>) and install.

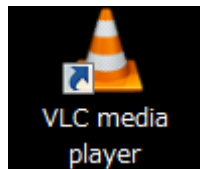

Open the VLC media player when the installation is complete.

Click on **Media <Open Network Stream** from the menu.

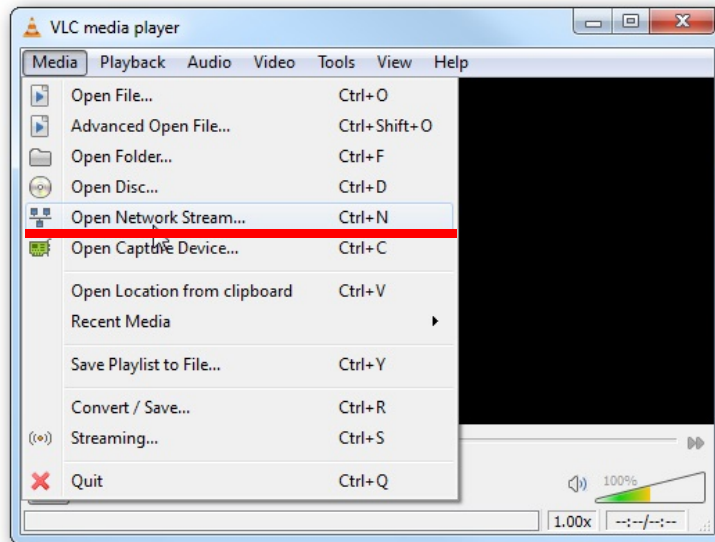

Figure 12. Setting to display video streaming with VLC (No.1)

Paste your copied URL in the 'Network Protocol' box and click "Play". Wait till the video start streaming in your VLC.

H.264 (main): rtsp:// "This camera IP Address" /h264

H.264 (sub): rtsp:// " This camera IP Address" /hsub

MJPEG: rtsp:// " This camera IP Address" /jpeg

(Example: rtsp://192.168.1.250/h264)

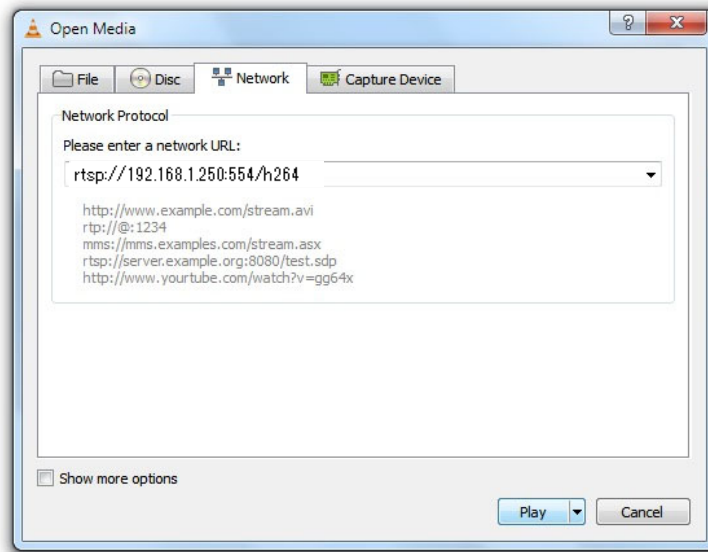

Figure 13. Setting to display video streaming with VLC (No.2)

Video starts to stream when the network connections and settings work property. Please check again the network settings if it does not start.

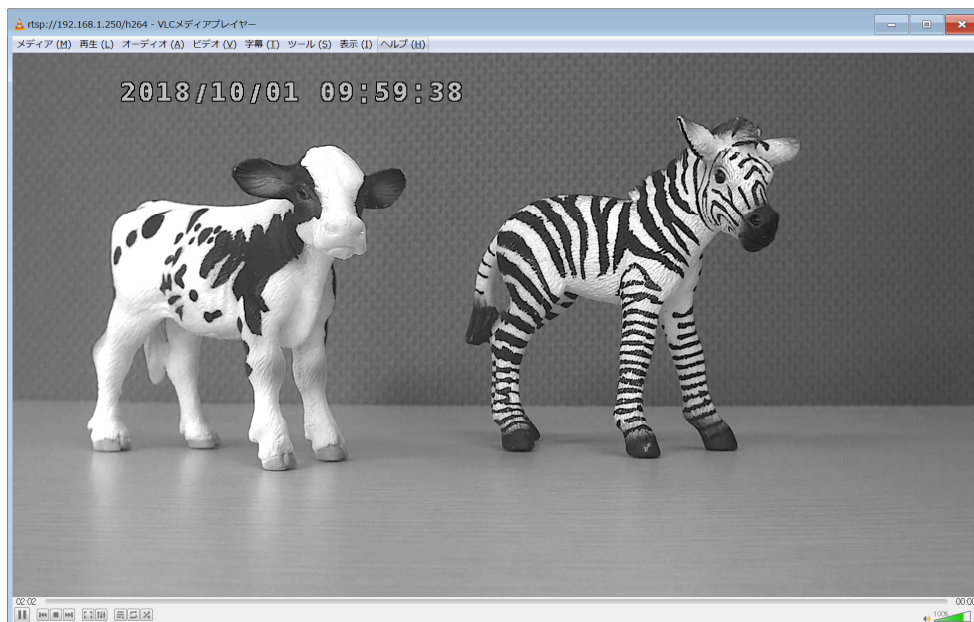

Figure 14. Streaming with VLC

The screen might become grey during the viewing, in that case, click the stop button in the lower left and click the play button again.

6. Changing the camera settings from the Web browser

You can change the system settings on this camera by a web browser.

It works on most operating systems and browsers, but your browser must support html5 and have JavaScript enabled.

The browsers whose operation has been confirmed are as follows.

Table 3. Correspondence table of operation confirmed OS and browser

	Windows10	iOS	Android	Linux(Debian)
Microsoft Edge	○	-	-	-
Google Chrome	○	○	○	-
Mozilla Firefox	○	-	○	○
Safari	-	○	-	-
Chromium	-	-	-	○

6.1. How to access the setting page

Here's how to access the setting page with a web browser.

Start the web browser and enter the following address.

`http://”This camera IP Address”/`

(Example: `http://192.168.1.250/`)

Or

`http://”This camera IP Address”/ index.html`

(Example: `http://192.168.1.250/ index.html`)

At the first time connection, the authentication window will open such as shown below.

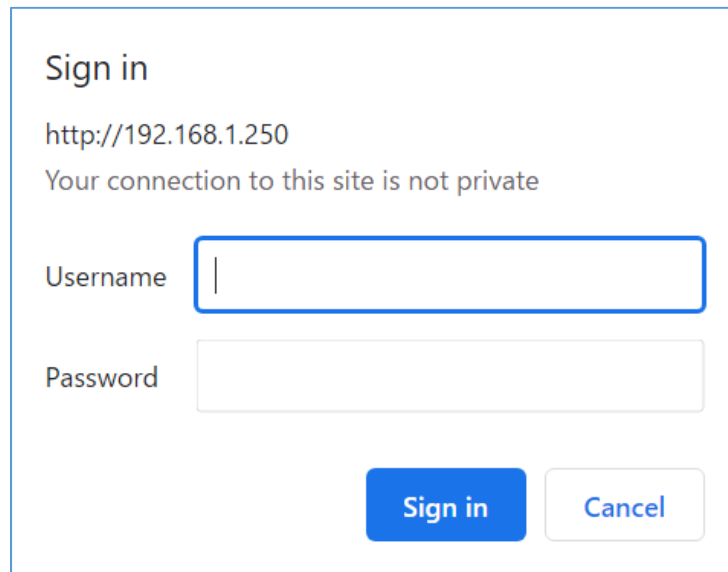

Figure 15. Authentication window for Google Chrome

The default username and password are:

User name: root

Password: "Serial Number" & "Last two digits of MAC address"

Note: For F/W ver.2.0.9 or earlier, the password will be "1234".

Example:

Serial number : W51512345

MAC Address : C4:7C8D:30:AB:CD

At this time, the password is "W51512345CD".

Enter the above and click "OK".

The user name and password can be changed on the "6.2.1.User Information" described later.

Note: If the page does not switch even if you input authentication information, check the input characters. If the authentication window does not appear, restart the web browser.

Note: Be sure to change the password, after the first login.

6.1.1. Overview (top page)

Open your web browser and go to the following address page.

This page displays the overview. This page is the top page.

Note: SD CARD SETUP of the menu is displayed only when the microSD card is inserted. If it is not displayed even though it is already inserted, please refresh the browser (F5).

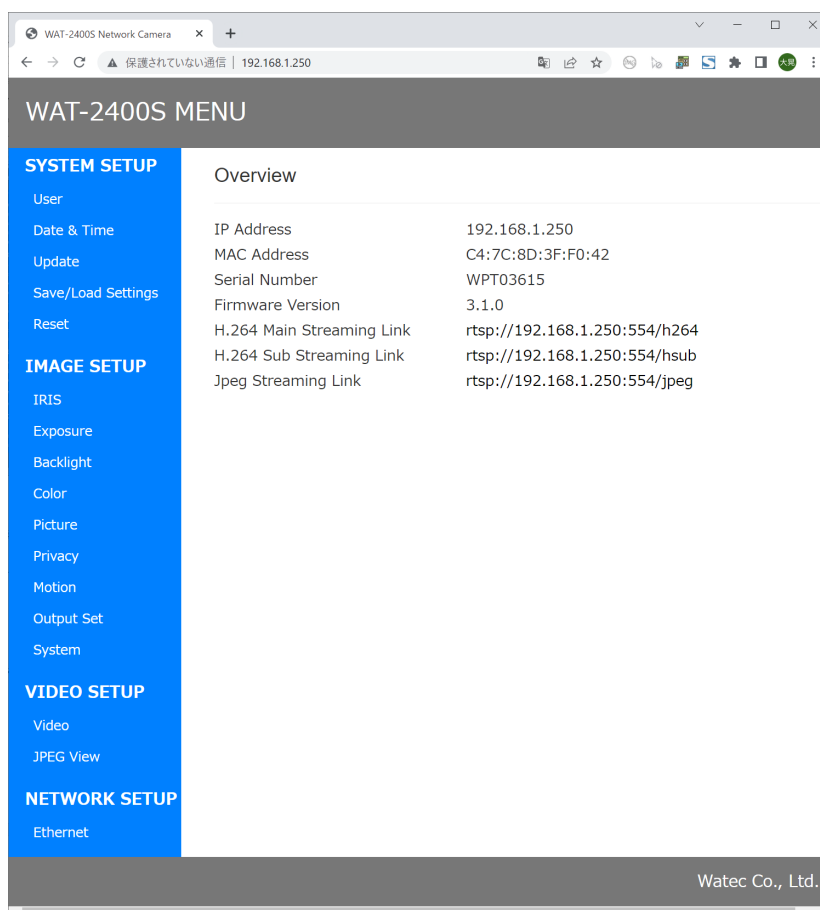

Figure 16. The Overview page (Top page)

The IP address, MAC address, Serial Number, microSD card capacity, F/W Version, and H.264 Main / H.264 Sub / Jpeg Streaming Link of this camera are displayed. The SD Card Size is displayed only when the microSD card is inserted.

The H.264 Main Streaming Link, H.264 Sub Streaming Link, and Jpeg Streaming Link are hyperlinks.

If the OS uses iOS, Android, Linux, etc. and VLC is installed, VLC will start automatically when you click the link. (Depending on the environment, a dialog for selecting the application to start may be displayed.)

You can also omit the character input by copying the link address and pasting it into the VLC network URL input field as shown in the figure below.

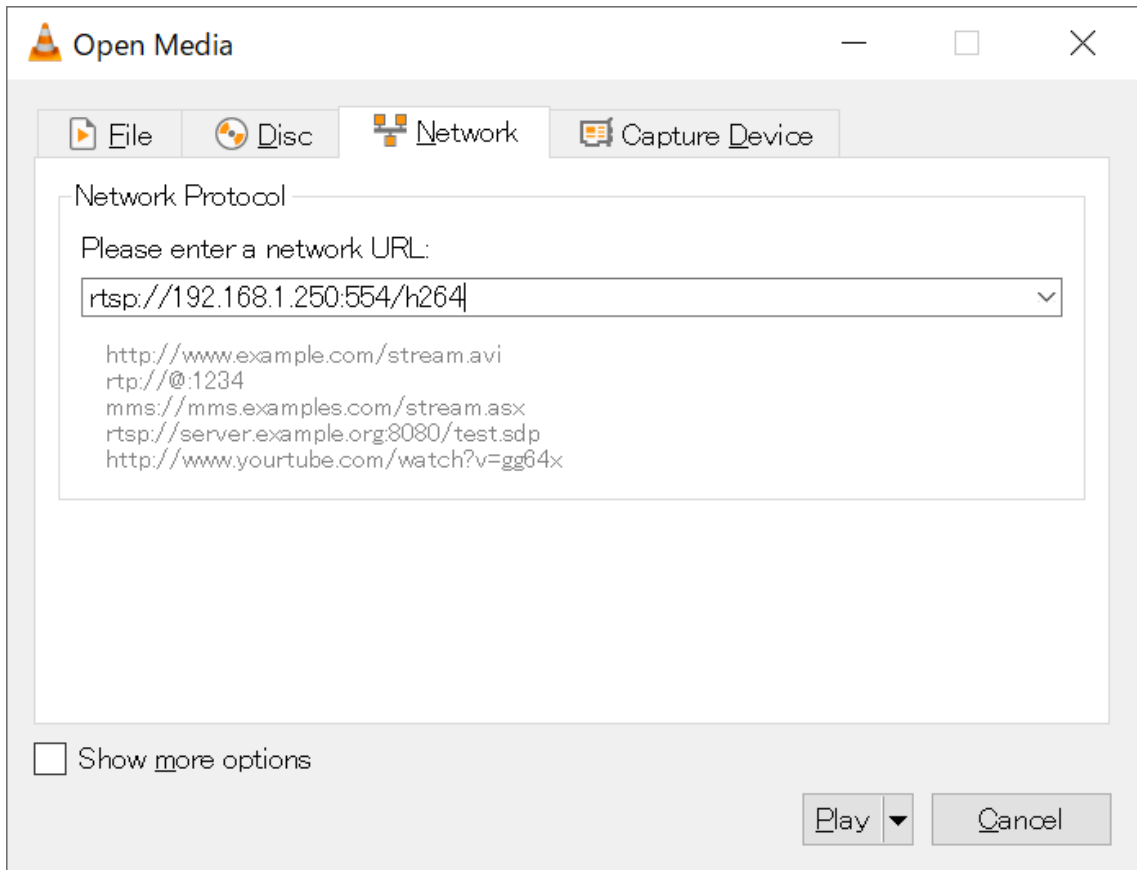

Figure 17. Paste to VLC

You can display each setting screen by clicking the menu on the left side of the screen. Each setting screen is explained below.

Note: SD Card Size will not be displayed correctly for 10 seconds after the camera is started. Please wait at least 10 seconds after the startup and reopen the page.

6.2. SYSTEM SETUP

6.2.1. User Information

Click "User" on menu to go to the User Information page.

Here you can set the ID and password used in each connection.

The screenshot shows a web interface for system setup. On the left is a blue sidebar menu with categories: SYSTEM SETUP (containing User, Date & Time, Update, Save/Load Settings, Reset), IMAGE SETUP (containing IRIS, Exposure, Backlight, Color, Picture, Motion, Output Set, System), VIDEO SETUP (containing Video, H.264 View, JPEG View), and NETWORK SETUP (containing Ethernet). The 'User' option is selected. The main content area is titled 'User Information' and contains a 'submit' button in the top right. Below the title are two sections. The first section has 'Current ID' with a text box containing 'root' and 'New ID' with an empty text box. The second section has 'Current Password', 'New Password', and 'Confirm' each with an empty text box.

Figure 18. The User Information page

Current ID

Displays the current ID.

It cannot be edited.

The default setting is "root".

New ID

Enter the ID you want to set.

If blank, no changes are made.

You can enter half-width alphanumerical characters and 4 types of symbols (. _ @).

Current Password

Re-enter the currently set password.

If the current password and the entered password do not match, the password will not be changed.

The default setting is "Serial Number" & "Last two digits of MAC address".

Note: Change the password regularly.

Note: For F/W ver.2.0.9 or earlier, the default password will be "1234".

New Password

Enter the password you want to change.

If blank, no changes are made.

You can enter half-width alphanumerical characters and 4 types of symbols (. _ @).

You can set a 4 to 12-digit password.

Confirm

Re-enter the password you want to change.

If it is different from what you entered in the New Password above, no changes will be made.

If blank, no changes are made.

You can enter half-width alphanumerical characters and 4 types of symbols (. _ @).

To update the setting value, please click "submit".

Please attention that the authentication window will be displayed again when you change ID or Password.

The ID and Password set here are commonly used for WEB setting page, ONVIF and FTP.

6.2.2. Date & Time

Click “Date & Time” on menu to go to the Date & Time page.

Here you can set the time to use in this camera.

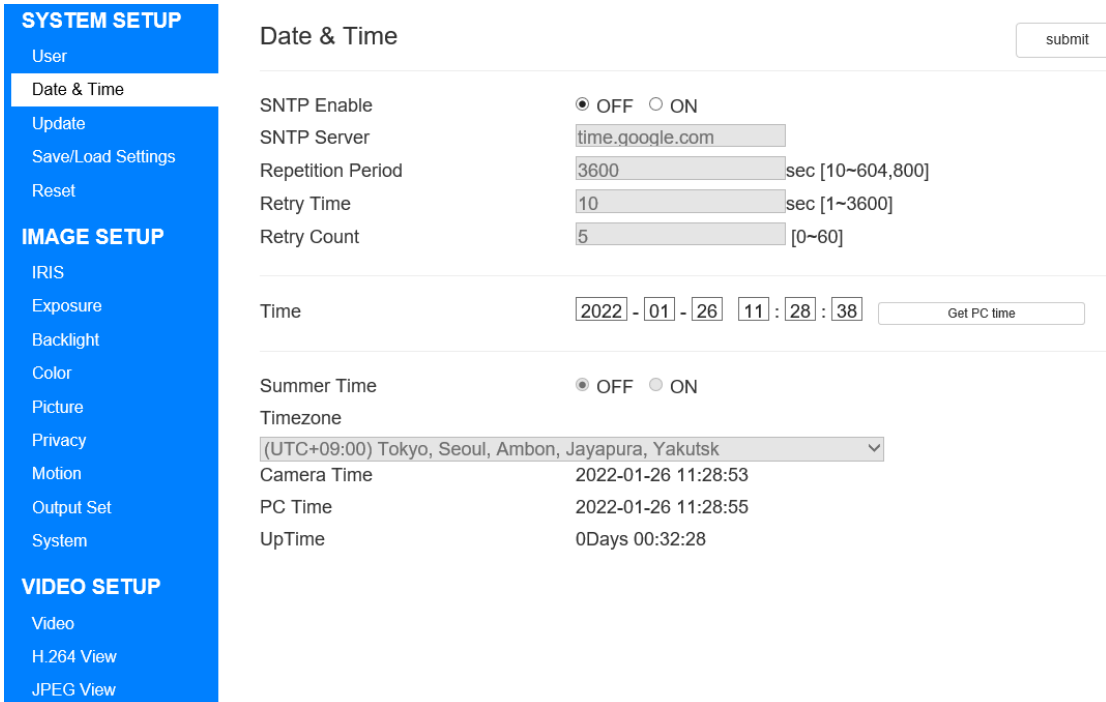

Figure 19. The Date & Time page

SNTP Enable

Use an external SNTP server to switch ON / OFF setting for time acquisition.

When this setting is ON, you can connect to the external SNTP server and synchronize time.

The default setting is “OFF”.

SNTP Server

It is enabled when SNTP Enable is ON.

Enter the IP address or server name of the external SNTP server.

You can enter half-width alphanumerical characters and 4 types of symbols (. _ @).

The default setting is “time.google.com”.

Repetition Period

It is enabled when SNTP Enable is ON.

Set the Repetition Period for synchronization with the SNTP server.

It can be set between 10 - 604800.

The default setting is "3600".

Retry Time

It is enabled when SNTP Enable is ON.

Set the retry time when connect to the SNTP server fails.

It can be set between 1 - 3600.

The default setting is "10".

Retry Count

It is enabled when SNTP Enable is ON.

Set the count of retries when connect to SNTP server fails.

It can be set between 0 - 60.

The default setting is "5".

Time

It is enabled when SNTP Enable is OFF.

Set the time of this camera.

You can match the client PC time with Get PC time.

Summer Time

It is enabled when SNTP Enable is ON.

Switch ON / OFF used of summer time.

The default setting is OFF.

Timezone

It is enabled when SNTP Enable is ON.

Select the time zone.

The default setting is "(UTC+09:00) Tokyo, Seoul, Ambon, Jayapura, Yakutsk".

Camera Time

The time of the camera is displayed.

Note: When you open this page for a long time, it will gradually deviate from the actual Camera Time.

If you want to see the actual Camera Time, please reopen this page.

PC Time

The time of the client PC is displayed.

UpTime

Displays the elapsed time since startup.

Note: When you open this page for a long time, it will gradually deviate from the actual UpTime.

If you want to see the actual UpTime, please reopen this page.

To update the setting value, please click the "submit" button.

6.2.3. Firmware Update

Click “Update” on menu to go to the Firmware Update page.

Here you can update the camera firmware.

Firmware Update		submit
Version Info	3.0.0	
Firmware Path	<input type="text" value="参照..."/>	

Figure 20. The Firmware Update page

Version Info

Displays the current firmware version.

Firmware Path

Select the firmware file that exists on the client PC.

To update the firmware, select Firmware Path, and click “submit”.

When the firmware is correctly transmitted, a progress bar will be displayed.

When the progress bar reaches 100%, the reboot confirmation message will be displayed, so select OK.

Please pay attention that the authentication window will be displayed again when ID or Password has been changed on the “6.2.1.User Information”.

6.2.4. Save/Load Settings

Click “Save/Load Settings” on menu to go to the Save/Load Settings page.

Here you can save and load the camera setting values.

Example: As shown in Figure 20, you can load the configuration file saved from an individual with the same individual or load it with another individual.

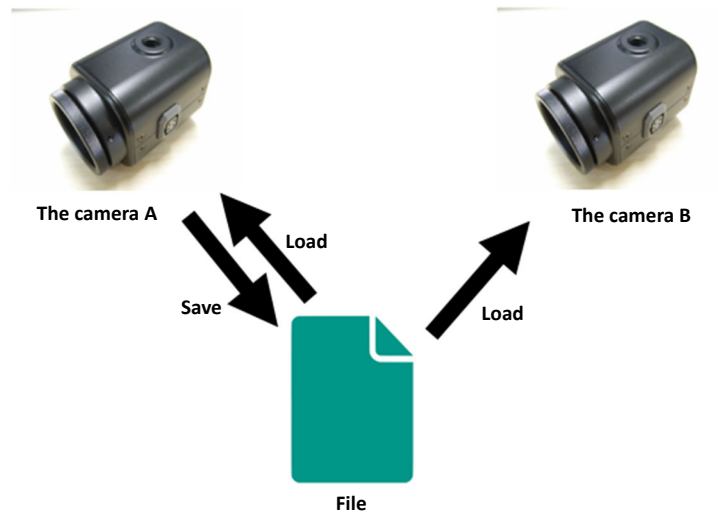

Figure 21. Example of using Save / Load Settings

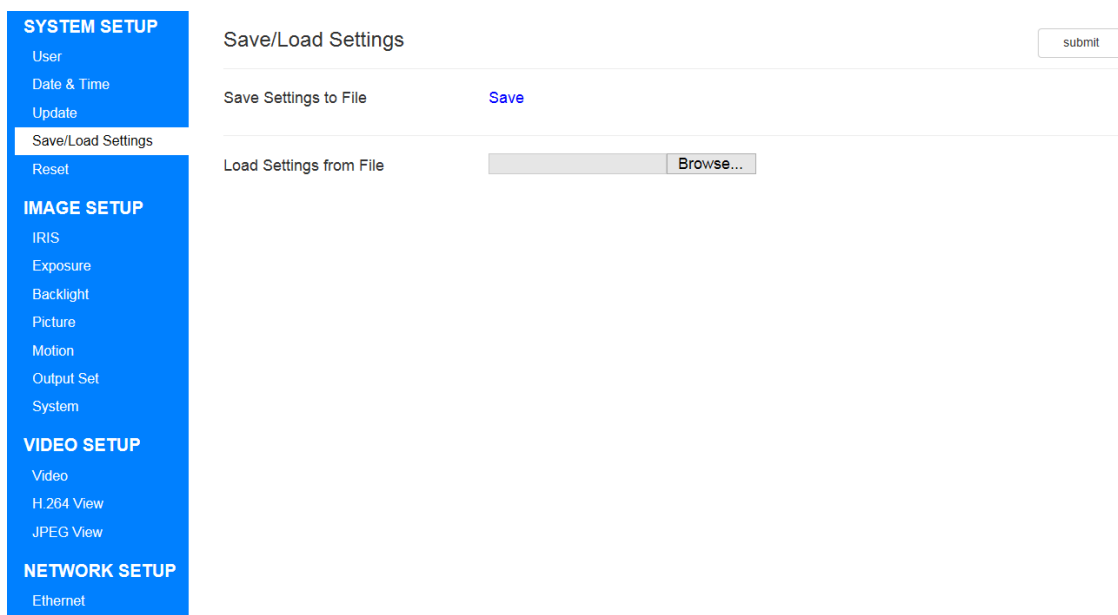

Figure 22. The Save/Load Settings page

Save Settings

Output the settings of this camera to a file and save it on the client PC.

The settings that can be saved are all settings that can be changed on the WEB setting page.

Click "Save" to save the configuration file (WAT-933_Setting.set or WAT-2400S_Setting.set) on the client PC.

Load Settings

Upload the file that output the settings of this camera from the client PC and load it.

Select the setting file (WAT-933_Setting.set or WAT-2400S_Setting.set) saved on the client PC.

To update the setting value, please click "submit".

When loading of the setting file is completed, a confirmation message of restart will be displayed. Please select "OK".

Please pay attention that the authentication window will be displayed again when ID or Password has been changed on the "6.2.1.User Information".

6.2.5. Reset

Click “Reset” on menu to go to the Reset page.

Here you can reset and reboot the camera.

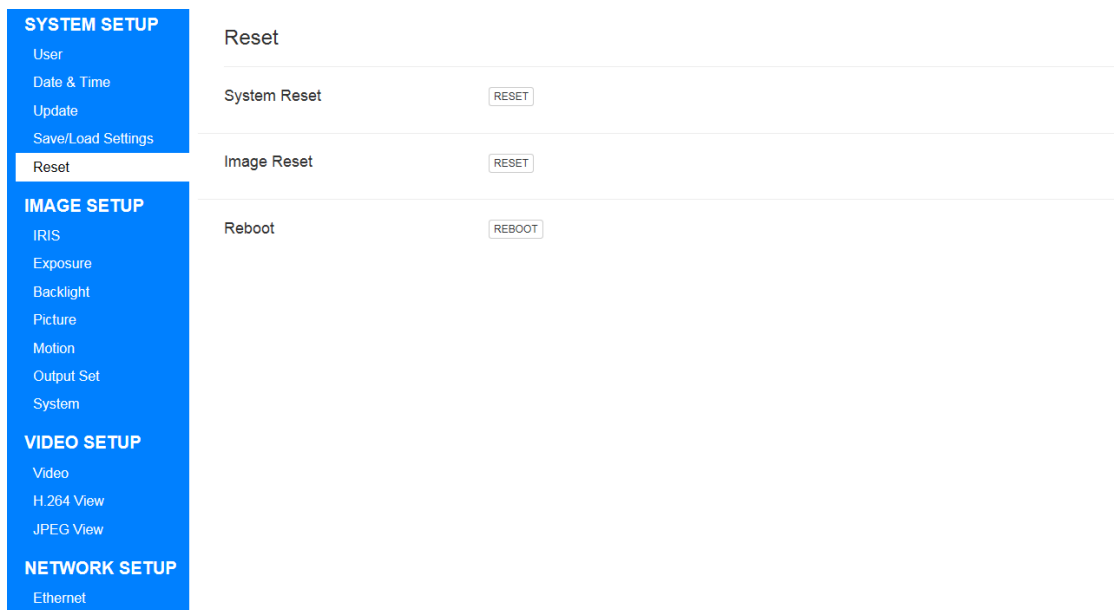

Figure 23. The Reset page

System Reset

Reset the settings other than IMAGE SETUP to the default settings.

It will be executed as soon as you click it.

Please pay attention that the authentication window will be displayed again when ID or Password has been changed on the User Information page.

Image Reset

Reset IMAGE SETUP to the default setting.

It will be executed as soon as you click it.

Reboot

Reboot the camera.

When you click on it, a reboot confirmation dialog will be displayed, select “OK” to reboot.

6.3. IMAGE SETUP

6.3.1. IRIS

Click “IRIS” on menu to go to the IRIS page.

Here you can set the IRIS mode.

The screenshot shows a web interface for camera settings. On the left is a blue sidebar with menu items grouped under 'SYSTEM SETUP', 'IMAGE SETUP', 'VIDEO SETUP', and 'NETWORK SETUP'. The 'IRIS' option under 'IMAGE SETUP' is highlighted. The main content area has 'IRIS' at the top right with a 'submit' button. Below it, the 'Mode' is set to 'ELC' in a dropdown menu.

Figure 24. The IRIS page

Mode

Select from the following 2.

Table 4. Selectable items of Mode

1	ELC	Electronic shutter control. Exposure control is performed with shutter speed and AGC, and the IRIS lens is fully opened.
2	ALC	Auto iris control. Exposure control is performed with iris and AGC, and the shutter speed is fixed.

The default setting is “ELC”.

This camera is compatible with DC iris lenses.

Note: When connecting a DC iris lens, be sure to turn off the power of this unit before connecting.

To update the setting value, please click the “submit” button.

6.3.2. Exposure

Click “Exposure” on menu to go to the EXPOSURE page.

Here you can set the exposure, brightness, gain, etc. of the sensor.

EXPOSURE		submit
Brightness	<input type="text" value="7"/> [0~20]	
Anti Saturation	<input checked="" type="radio"/> OFF <input type="radio"/> ON	
Weight	<input type="text" value="10"/> [0~20]	
Shutter	<input type="text" value="Auto"/>	
Mode	<input type="text" value="Normal"/>	
Speed	<input type="text" value="1/30"/>	
Slow Shutter	<input type="text" value="OFF"/>	
AGC Max	<input type="text" value="72"/> dB [0~72]	
AGC Min	<input type="text" value="0"/> db [0~72]	
AE SPEED	<input type="text" value="10"/> [0~20]	

Figure 25. The EXPOSURE page

Brightness

Set the brightness of the image.

It can be set between 0 - 20.

The smaller the value, the darker it is, the larger it gets brighter.

The default setting is “7”.

Anti Saturation

Switch ON / OFF Anti Saturation function.

The default setting is "OFF".

Note: About Anti Saturation Function

AE control is performed according to the high brightness area that saturates as shown in the following example to improve visibility.

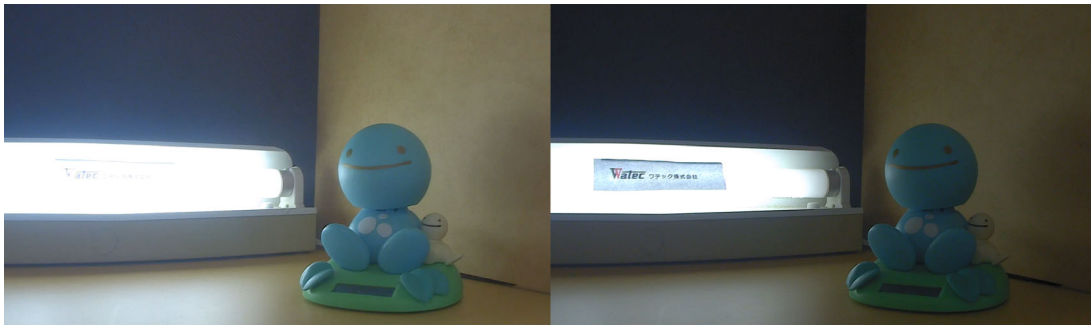

Figure 26. (Left)Anti Saturation:OFF, (Right)Anti Saturation:ON

When the Mode on the "6.3.1.IRIS" is ELC and the Shutter is Manual, this function does not work.

And when the Mode on the "6.3.8.Output Set" is "WDR15fps(WDR12fps)" or "WDR30fps(WDR25fps)", this function does not work.

Weight

It is enabled when Anti Saturation is ON.

Set whether to adjust to the high brightness area or the middle-low brightness area.

It can be set between 0 - 20.

The higher the value, the brightness will be adjusted on high brightness area.

The default setting is "10".

Shutter

Select from the following 3.

Table 5. Selectable items of Shutter

1	Auto	When Mode of "6.3.1.IRIS" is ELC, shutter speed is automatically controlled. For ALC, fix the shutter speed to 1/30 or 1/25.
2	Manual	Set the shutter speed to an arbitrary fixed value. (See Table 7)
3	Flicker	Fix the shutter speed at 1/100 or 1/120, reducing the flicker phenomenon.

The default setting is "Auto".

Mode

It is enabled when Shutter is "Auto".

This items that can be selected differ depending on the Mode setting on the "6.3.1. IRIS".

When Mode of the "6.3.1.IRIS" is ELC, select from the following two.

Table 6. Selectable items of Mode (When IRIS Mode is ELC)

1	Normal	Normal mode.
2	Deblur	Adjusting the shutter speed and AGC will reduce motion blur.

When Mode of "6.3.1.IRIS" is ALC, select from the following two.

Table 7. Selectable items of Mode (When IRIS Mode is ALC)

1	Indoor	Exposure control is performed by normal IRIS control.
2	Outdoor	Adjust the shutter speed so as not to excessively narrow the IRIS in a strong light environment.
3	Deblur	Adjusting the shutter speed and AGC will reduce motion blur.

The default setting is "Normal".

Speed

It is enabled when Shutter is Manual.

The select items will change according to the Frequency of the "6.3.8. OUTPUT SET" which will be described later.

List items that can be selected below.

Table 8. Selectable items of Speed

When Frequency is 60Hz	When Frequency is 50Hz
1/30	1/25
1/60	1/50
1/120	1/100
1/250	1/200
1/500	1/400
1/1000	1/800
1/2000	1/1600
1/4000	1/3200
1/8000	1/6400
1/15000	1/12800
1/30000	1/25600

The default setting is "1/30" or "1/25".

Slow Shutter

It is disabled when shutter is Manual.

It is also disable when Mode of the "6.3.8. OUTPUT SET" which will be described later is WDR 15fps (WDR 12fps) , WDR 30fps (WDR 25fps) or DNR 30fps (DNR 25 fps).

The slow shutter increases the sensitivity.

It can be selected from OFF / x2 / x4 / x8 / x16 / x32.

The default setting is "OFF".

AGC MAX

Set the maximum gain.

It can be set between 0 - 72 dB.

The default setting is "72".

AGC MIN

Set the minimum gain.

It can be set between 0 - 72 dB.

When Shutter is Auto, it will be disabled.

Note: Setting a value higher than the AGC MAX will automatically have the same value as the AGC MAX.

The default setting is "0".

Note: Relationship between AGC and Slow Shutter

When both AGC and Slow Shutter are working, exposure control by AGC takes precedence. Therefore, as shown in the figure, Slow Shutter may not work if it converges to the target brightness only with AGC.

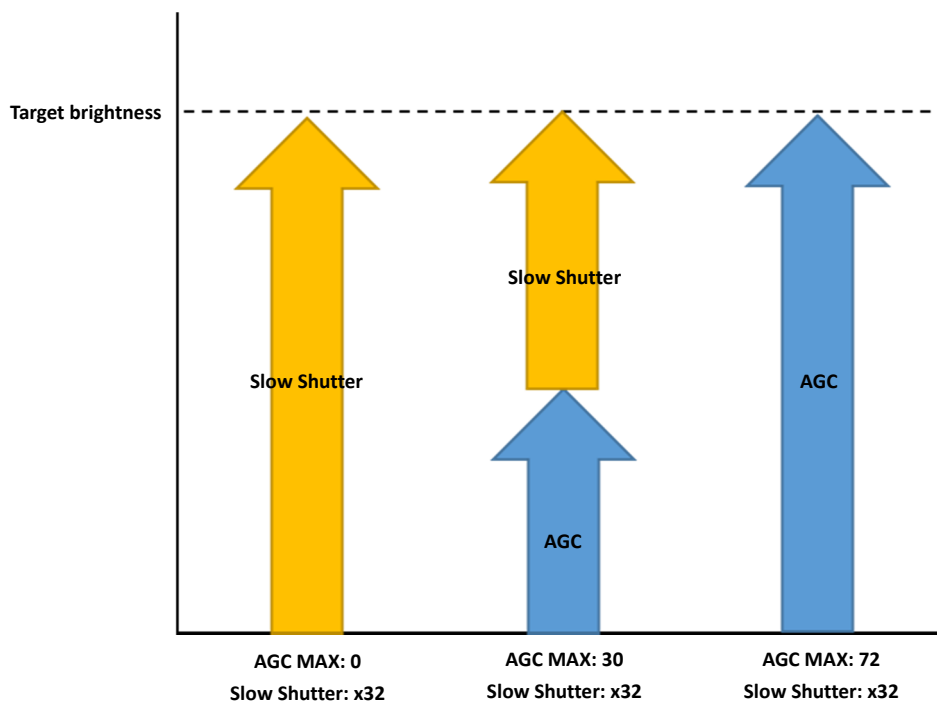

Figure 27. Relationship between AGC and Slow Shutter

AE Speed

Set the AE convergence speed.

It affects control speed of shutter speed , IRIS and AGC change.

It can be set between 0 - 20.

The smaller the value, the slow it is, the larger it gets fast.

The default setting is "10".

To update the setting value, please click the "submit" button.

6.3.3. Backlight

Click “Backlight” on menu to go to the BACKLIGHT page.

Here you can set the backlight and highlight compensation.

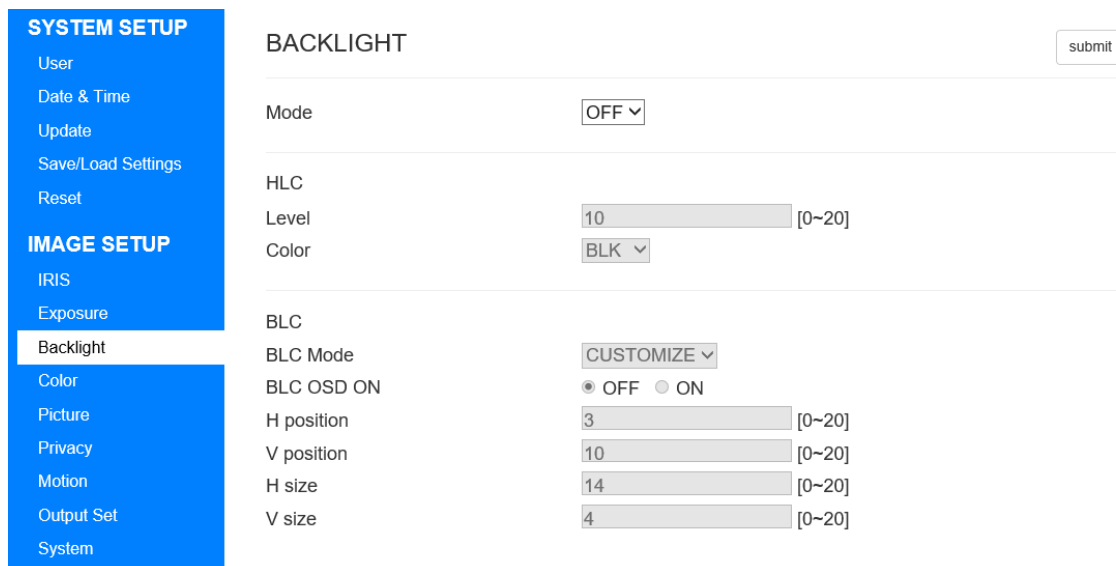

Figure 28. The BACKLIGHT page

Mode

Select from the following 3.

Table 9. Selectable items of Mode

1	OFF	Backlight compensation is not used.
2	HLC	Highlight compensation is used. Highlight compensation is aimed at reducing the burden on the observer by improving the visibility by applying mask processing to intense light. It cannot be set when the Mode of "6.3.8.Output Set" described later is WDR 15fps (WDR 12fps) or WDR 30fps (WDR 25fps).
3	BLC	Backlight compensation is used. Backlight compensation is to increase the brightness of the entire image and make the subject that is blackened by backlighting to the appropriate brightness.

The default setting is “OFF”.

HLC - Level

It is enabled when Mode is "HLC".

Set the mask brightness level.

It can be set between 0 - 20.

The smaller the value, the lower the brightness threshold of the mask, and the larger the value, the higher the brightness threshold of the mask.

The default setting is "10".

HLC - Color

It is enabled when Mode is "HLC".

Set the mask color.

You can select from WHT / YEL / CYN / GRN / MAG / RED / BLU / BLK.

The default setting is "BLK".

BLC – BLC Mode

It is enabled when Mode is "BLC".

Set the range mode of the backlight compensation area.

Table 10. Selectable items of Mode

1	CUSTOMIZE	Set the backlight compensation area by H position / V position / H size / V size described later.
2	CENTER	Set the center of the imaging range to the backlight compensation area.
3	SPOT	Set the narrow spot in the center of the image pickup area as the backlight compensation area.

The default setting is "CUSTOMIZE".

BLC – BLC OSD ON

It is enabled when Mode is "BLC".

Set visibility of backlight compensation area.

The default setting is "OFF".

BLC - H position

It is enabled when Mode is "BLC".

Set the horizontal start position of the backlight compensation area.

It can be set between 0 - 20.

The smaller the value, to the left moves, and the larger the value, to the right moves.

The default setting is "3".

BLC - V position

It is enabled when Mode is "BLC".

Set the vertical start position of the backlight compensation area.

It can be set between 0 - 20.

The smaller the value, to the up moves, and the larger the value, to the down moves.

The default setting is "10".

BLC - H size

It is enabled when Mode is "BLC".

Set the horizontal size of the backlight compensation area.

It can be set between 0 - 20.

The smaller the value, to the left moves, and the larger the value, to the right moves.

The default setting is "14".

BLC - V size

It is enabled when Mode is "BLC".

Set the vertical size of the backlight compensation area.

It can be set between 0 - 20.

The smaller the value, to the up moves, and the larger the value, to the down moves.

The default setting is "4".

To update the setting value, please click "submit".

6.3.4. Color

Click “Color” on menu to go to the COLOR page.

Here you can set such as the auto white balance.

This page is only WAT-2400S.

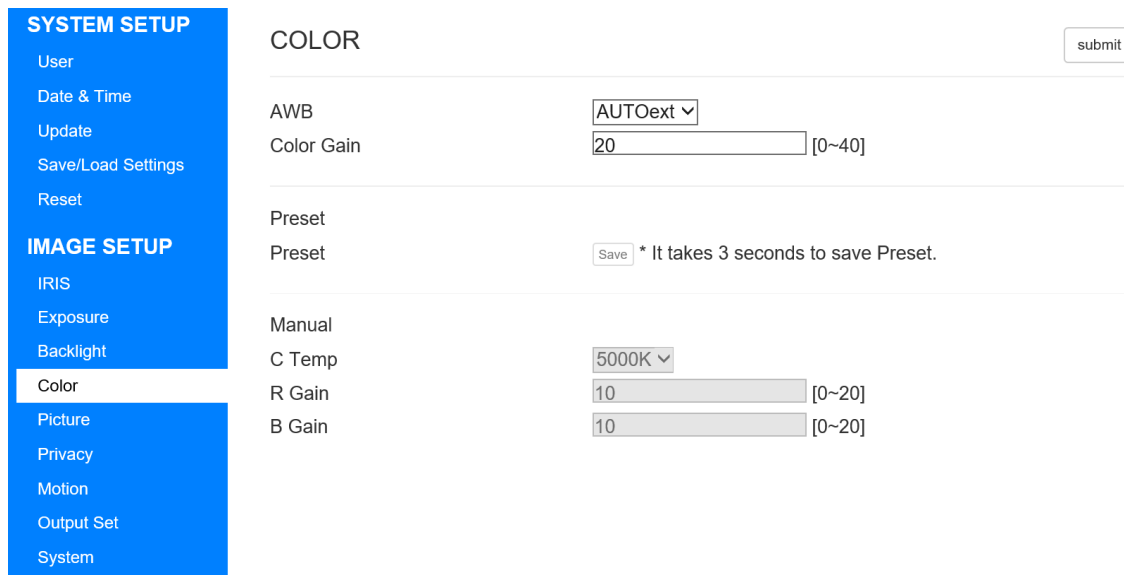

Figure 29. The COLOR page

AWB

Set the auto white balance.

Select from the following four.

Table 11. Selectable items of AWB

1	AUTO	Automatically performs white balance control.
2	AUTOext	White balance control is automatically performed at a color temperature range wider than AUTO. If the range is too wide, set it to AUTO.
3	PRESET	The white balance can be automatically corrected according to the environment, and the compensation value can be fixed. Please see Preset below for details.
4	MANUAL	You can select from a predetermined color temperature.

The default setting is “AUTOext”.

Color Gain

Set the color gain. It can be set between 0 - 40.

The smaller the value, the lower the saturation, and the larger the value, the higher the saturation.

The default setting is "20".

Preset

It is enabled when AWB is "PRESET". Set the preset white balance.

The white balance will be adjusted for about 3 seconds after you press the Save button.

After adjustment, the white balance is fixed until the Save button is pressed again.

C Temp

It is enabled when AWB is "MANUAL". Set the color temperature.

You can be select from 3000K / 5000K / 8000K.

The default setting is "5000K".

R Gain

It is enabled when AWB is "MANUAL". Set the red gain.

It can be set between 0 - 20.

The smaller the value, the negative compensation is applied to the R component.

The larger the value, the positive compensation is applied to the R component.

The default setting is "10".

B Gain

It is enabled when AWB is "MANUAL". Set the blue gain.

It can be set between 0 - 20.

The smaller the value, the negative compensation is applied to the B component.

The larger the value, the positive compensation is applied to the B component.

The default setting is "10".

To update the setting value, please click "submit".

6.3.5. Picture

Click "Picture" on menu to go to the PICTURE page.

Here you can set such as the sharpness, contrast of the image.

SYSTEM SETUP	
User	
Date & Time	
Update	
Save/Load Settings	
Reset	

IMAGE SETUP	
IRIS	
Exposure	
Backlight	
Color	
Picture	
Privacy	
Motion	
Output Set	
System	

VIDEO SETUP	
Video	
H.264 View	
JPEG View	

PICTURE	
Gamma	AUTO
AUTO DAY	0.55
AUTO NIGHT	0.45
Sharpness	5 [0~10]
Mirror	<input checked="" type="radio"/> OFF <input type="radio"/> ON
Flip	<input checked="" type="radio"/> OFF <input type="radio"/> ON
ACE	OFF
Defog	<input checked="" type="radio"/> OFF <input type="radio"/> ON
Mode	AUTO
Level	MIDDLE

Figure 30. The PICTURE page

Gamma

Set the gamma correction.

It can be selected from 0.45 / 0.5 / 0.55 / 0.6 / 0.65 / 0.7 / 0.75 / AUTO.

The default setting is "AUTO".

AUTO DAY

It is enabled when Gamma is "AUTO".

Set the lower limit of gamma correction when the average brightness of the image is bright.

It can be select from 0.45 / 0.5 / 0.55 / 0.6 / 0.65 / 0.7 / 0.75.

The default setting is "0.55".

AUTO NIGHT

It is enabled when Gamma is "AUTO".

Set the upper limit of gamma correction when the average brightness of the image is dark.

It can be select from 0.45 / 0.5 / 0.55 / 0.6 / 0.65 / 0.7 / 0.75.

The default setting is "0.45".

Note: When Gamma is AUTO, in the range of AUTO DAY to AUTO NIGHT

Gamma correction is performed.

Sharpness

Set the sharpness.

It can be set between 0 - 10.

The smaller the value, the lower the sharpness, and the larger the value, the higher the sharpness.

The default setting is "5".

Mirror

Switch ON / OFF of left / right reversal.

The default setting is "OFF".

Flip

Switch ON / OFF of upside-down.

The default setting is "OFF".

ACE

Set the contrast.

It can be selected from OFF / LOW / MIDDLE / HIGH.

The default setting is "OFF".

Defog

Switch ON / OFF use of defog correction.

Defog correction improves visibility deteriorated by fog, snow, dust etc.

The default setting is "OFF".

Defog - Mode

It is enabled when Defog is "ON".

It can be selected from MANUAL / AUTO.

When this item is MANUAL, fog correction is always performed.

When this item is AUTO, fog correction is automatically performed as necessary.

The default setting is "AUTO".

Defog - Level

It is enabled when Defog is "ON".

It can be selected from LOW / MIDDLE / HIGH.

The default setting is "MIDDLE".

To update the setting value, please click "submit".

6.3.6. Privacy

Click “Privacy” on menu to go to the PRIVACY page.

Here you can set such as the Privacy Mask.

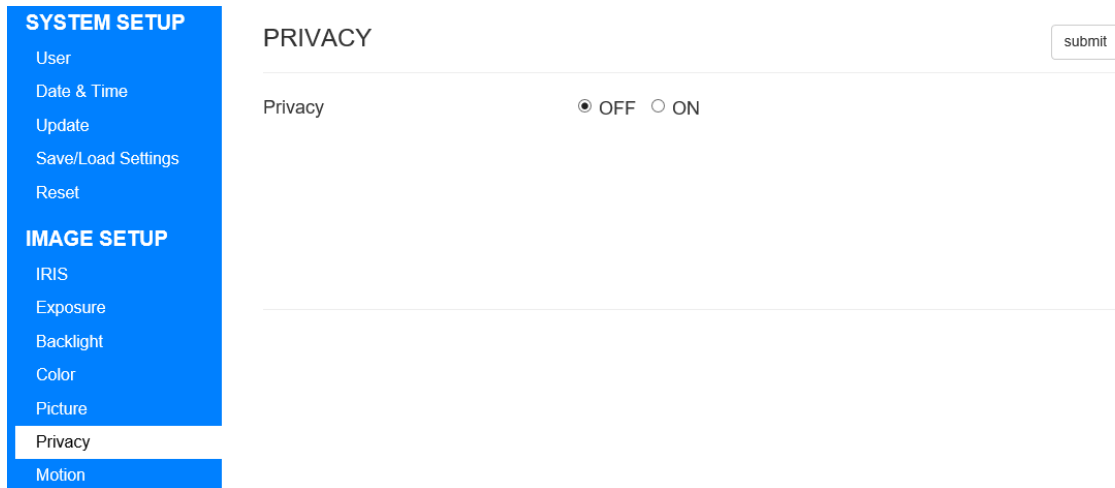

Figure 31. The PRIVACY page(When OFF)

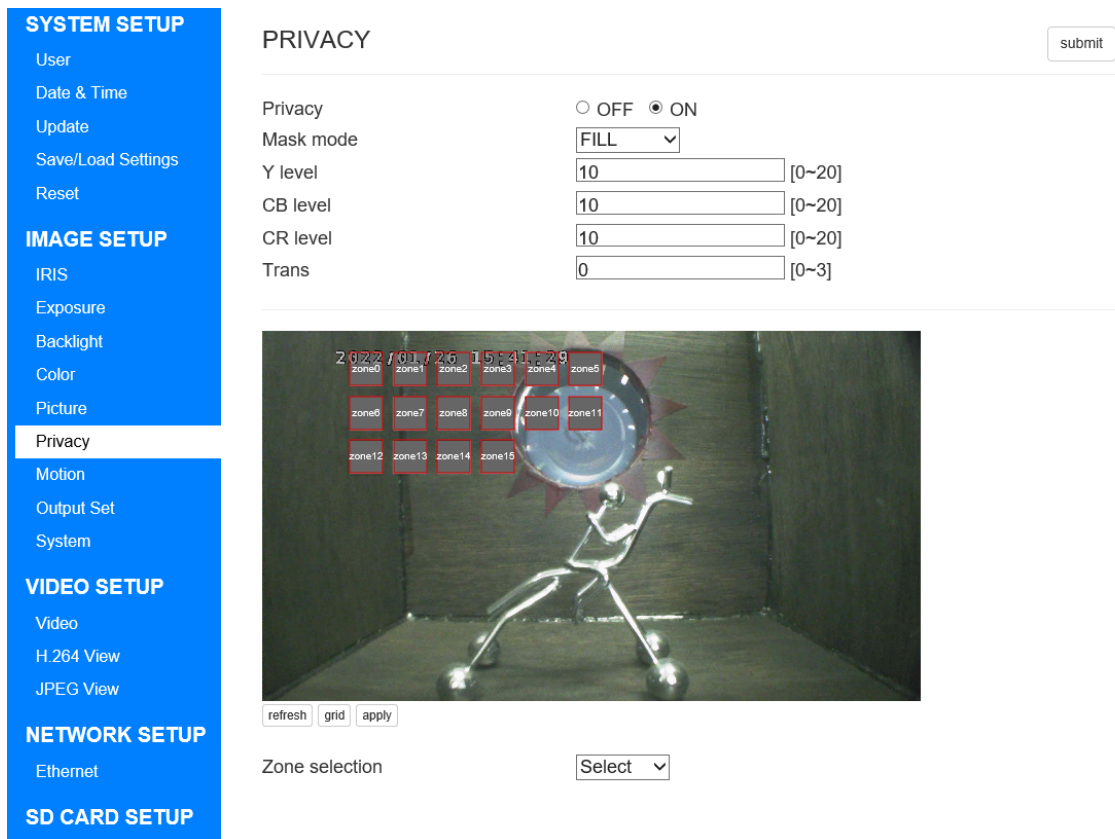

Figure 32. The PRIVACY page(When ON)

Privacy

Switch ON / OFF use of privacy mask.

The default setting is "OFF".

Mask mode

It is enabled when Privacy is "ON".

It can be selected from FILL / FORMAT.

When this item is FILL, fill the mask area.

When this item is FORMAT, make the mask area black and white reversed.

The default setting is "FILL".

Y level

It is enabled when Privacy is "ON".

Set the brightness of the mask color.

It can be set between 0 - 20.

The smaller the value, the lower the brightness, and the larger the value, the higher the brightness.

The default setting is "10".

CB level

It is enabled when Privacy is "ON".

Set the intensity of the B component of the mask color.

It can be set between 0 - 20.

The smaller the value, the lower the intensity of B component, the larger value, the higher the intensity of B component.

The default setting is "10".

CR level

It is enabled when Privacy is "ON".

Set the intensity of the R component of the mask color.

It can be set between 0 - 20.

The smaller the value, the lower the intensity of R component, the larger value, the higher the intensity of R component.

The default setting is "10".

Trans

It is enabled when Privacy is "ON".

Set the transparency of the mask.

It can be set between 0 - 3.

The smaller the value, the lower the transparency, the larger the value, the higher the transparency.

The default setting is "0".

Simulated image

It is enabled when Privacy is "ON".

refresh

Updates the simulated image to the current image.

grid

Overwrites the grid lines on the simulated image.

apply

It has the same effect as the submit button.

Zone selection

It is enabled when Privacy is “ON“.

It can be set between Zone0 - 15.

When you select Zone, the following setting items are displayed.

SYSTEM SETUP

- User
- Date & Time
- Update
- Save/Load Settings
- Reset

IMAGE SETUP

- IRIS
- Exposure
- Backlight
- Color
- Picture
- Privacy
- Motion
- Output Set
- System

VIDEO SETUP

- Video
- H.264 View
- JPEG View

NETWORK SETUP

- Ethernet

SD CARD SETUP

- Info
- Schedule
- Timelapse

PRIVACY

submit

Privacy OFF ON

Mask mode

Y level [0~20]

CB level [0~20]

CR level [0~20]

Trans [0~3]

2022/01/26 15:41:29
zone0

refresh grid apply

Zone selection

Privacy Zone OFF ON

Position X

Position Y

Width Size

Height Size

Figure 33. The PRIVACY page(Selected the Zone selection)

The setting items of each mask are explained below.

- A) Privacy Zone
Switch display ON / OFF of each mask.
- B) Position X
Sets the horizontal start position of each mask.
- C) Position Y
Sets the vertical start position of each mask.
- D) Width Size
Sets the Width Size of each mask.
- E) Height Size
Sets the Height Size of each mask.

Please pay attention that you need to click “submit” next to each mask setting when updating the setting of each mask.

6.3.7. Motion

Click “Motion” on menu to go to the MOTION page.

Here you can set motion detection.

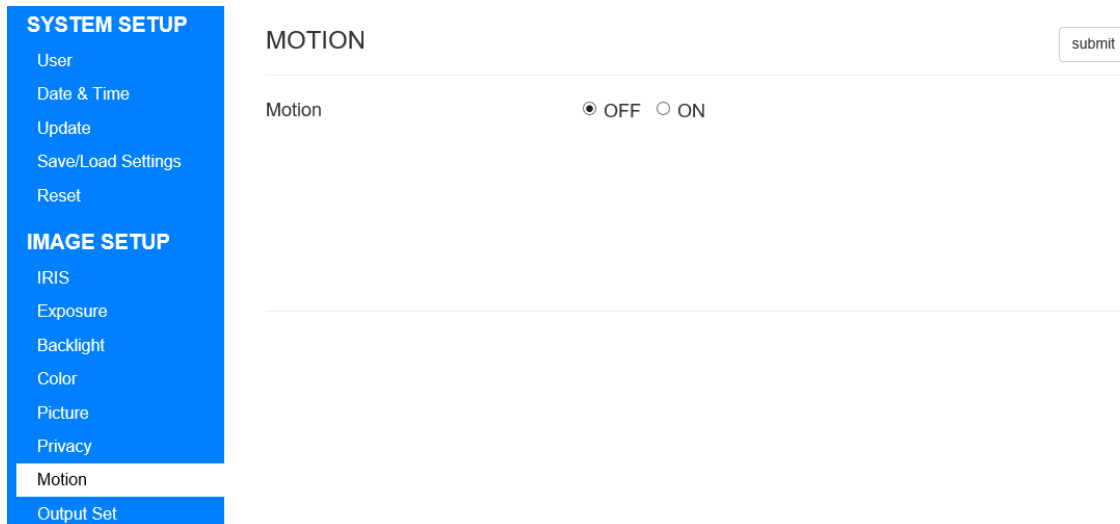

Figure 34. The MOTION page(When OFF)

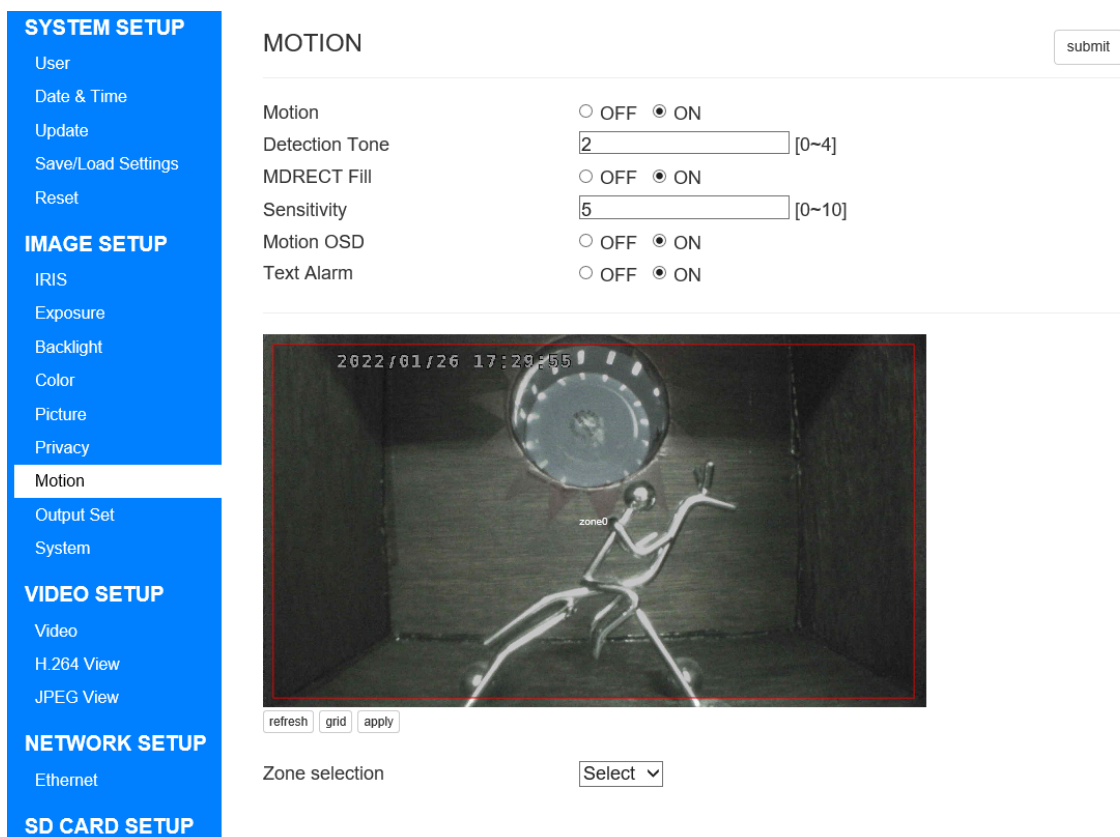

Figure 35. The MOTION page(When ON)

Motion

Switch ON / OFF use of the motion detection.

The default setting is "OFF".

Detection Tone

It is enabled when MOTION is "ON".

Set the display method of effective area of motion detection.

It can be set between 0 - 4.

Table 12. Selectable items of DETECTION TONE

0	The detection range is displayed with a white frame.
1	The detection range is displayed with the transparent frame.
2	The detection range is displayed as a transparent frame with higher transparency than 1.
3	The detection range is not displayed.
4	The detection range is displayed with the thin green frame.

The default setting is "2".

MDRECT Fill

It is enabled when MOTION is "ON".

Switch the ON / OFF of the fill of the motion detection area.

The default setting is "ON".

Sensitivity

It is enabled when MOTION is "ON".

Set the sensitivity of motion detection.

It can be set between 0 - 10.

The smaller the value, the lower the sensitivity, and the larger the value, the higher the sensitivity.

The default setting is "5".

Motion OSD

It is enabled when MOTION is "ON".

Switch ON / OFF of OSD display at motion detection.

The default setting is "ON".

Text Alarm

It is enabled when MOTION is "ON".

Switch ON / OFF of the text display of motion detection.

The default setting is "ON".

Simulated image

It is enabled when Privacy is "ON".

refresh

Updates the simulated image to the current image.

grid

Overwrites the grid lines on the simulated image.

apply

It has the same effect as the submit button.

Zone selection

It is enabled when MOTION is “ON”.

It can be set between Zone0 - 3.

When you select Zone, the following setting items are displayed.

SYSTEM SETUP

- User
- Date & Time
- Update
- Save/Load Settings
- Reset

IMAGE SETUP

- IRIS
- Exposure
- Backlight
- Color
- Picture
- Privacy

Motion

- Output Set
- System

VIDEO SETUP

- Video
- H.264 View
- JPEG View

NETWORK SETUP

- Ethernet

SD CARD SETUP

- Info
- Schedule
- Timelapse

MOTION submit

Motion OFF ON

Detection Tone [0~4]

MDRECT Fill OFF ON

Sensitivity [0~10]

Motion OSD OFF ON

Text Alarm OFF ON

2022/01/26 17:29:55

zone0

refresh grid apply

Zone selection

Motion Zone OFF ON

Position X

Position Y

Width Size

Height Size

Figure 36. The MOTION page(When ON)

The setting items of each zone are explained below.

- A) Motion Zone
Switch ON / OFF enable of each zone.
- B) Position X
Sets the horizontal start position of each zone.
- C) Position Y
Sets the vertical start position of each zone.
- D) Width Size
Sets the Width size of each zone.
- E) Height Size
Sets the Height size of each zone.

Please pay attention that you need to click “submit” next to each zone setting when updating the setting of each zone.

6.3.8. Output Set

Click “Output” Set on menu to go to the OUTPUT SET page.

Here you can set Sensor output.

Figure 37. The OUTPUT SET page

Mode

The settings that can be selected will change depending on the Frequency setting described below.

When Frequency is 60Hz, select from the following 5.

Table 13. Selectable items of Mode (When Frequency is 60Hz)

1	Normal 30fps	Takes with 30fps Normal.
2	Normal 60fps	Takes with 60fps Normal. However, streaming and recording at 60fps is possible only when the resolution of H.264 Main is 720P or less. Note: Reference "6.4.1. Video".
3	DNR 30fps	Takes with 30fps 3D Digital Noise Reduction.
4	WDR 15fps	Takes with 15fps Wide Dynamic Range. The wide dynamic range is a setting that combines two frames with different exposure times and expands the dynamic range.
5	WDR 30fps	Takes with 30fps Wide Dynamic Range.

The default setting is “DNR 30fps”.

When Frequency is 50Hz, select from the following 5.

Table 14. Selectable items of Mode (When Frequency is 50Hz)

1	Normal 25fps	Takes with 25fps Normal.
2	Normal 50fps	Takes with 50fps Normal. However, streaming and recording at 50fps is possible only when the resolution of H.264 Main is 720P or less. Note: Reference "6.4.1. Video".
3	DNR 25fps	Takes with 25fps 3D Digital Noise Reduction.
4	WDR 12fps	Takes with 12fps Wide Dynamic Range.
5	WDR 25fps	Takes with 25fps Wide Dynamic Range.

The default setting is "DNR 25fps".

Level

It is enabled when Mode is DNR 30fps(DNR 25fps) / WDR 15fps(WDR 12fps) / WDR 30fps(WDR 25fps).

It can be selected from LOW / MIDDLE / HIGH.

The default setting is "MIDDLE".

Frequency

It can be selected from 50Hz / 60Hz.

The default setting is "60Hz".

To update the setting value, please click "submit".

6.3.9. System

Click “System” on menu to go to the SYSTEM page.

Here you can set Color bar and Title.

The screenshot shows a web interface for system configuration. On the left is a blue sidebar with a menu. The 'SYSTEM SETUP' section includes 'User', 'Date & Time', 'Update', 'Save/Load Settings', and 'Reset'. The 'IMAGE SETUP' section includes 'IRIS', 'Exposure', 'Backlight', 'Color', 'Picture', 'Privacy', 'Motion', and 'Output Set'. The 'VIDEO SETUP' section includes 'System', which is currently selected. The main content area is titled 'SYSTEM' and features a 'submit' button in the top right. Below the title, there are two settings: 'Color bar' with radio buttons for 'OFF' (selected) and 'ON', and 'Cam Title' with a dropdown menu set to 'OFF' and a text input field below it.

Figure 38. The SYSTEM page

Color bar

Switch ON / OFF of the Color bar.

The default setting is “OFF”.

Cam Title

You can set the title to be displayed to the image.

It can be selected from OFF / Right up / Left down.

The title is allowed 8 alphanumeric characters.

Characters that can be output are half-width alphanumerical characters and half-width symbols (excluding the five types of “¥~|{}”).

If a character that cannot be output is set, it will be replaced with a single-byte space.

To update the setting value, please click “submit”.

6.4. VIDEO SETUP

6.4.1. Video

Click “Video” on menu to go to the Video Information page.

Here you can set streaming etc.

SYSTEM SETUP

- User
- Date & Time
- Update
- Save/Load Settings
- Reset

IMAGE SETUP

- IRIS
- Exposure
- Backlight
- Color
- Picture
- Privacy
- Motion
- Output Set
- System

VIDEO SETUP

- Video**
- H.264 View
- JPEG View

NETWORK SETUP

- Ethernet

SD CARD SETUP

- Info
- Schedule
- Timelapse

Video Information submit

Max Resolution 1920 X 1080
Max FPS 30FPS
Output Mode 30FPS DNR

Recording time 3 min

RTSP Port 554 [1~65535]
HTTP & ONVIF Port 80 [1~65535]
Note: This port changes will be reflected on reboot.

Authenticate streaming ON OFF

Select Recording H.264 MAIN H.264 SUB

Timestamp Display ON OFF

Mix Audio with Streaming & Recoding ON OFF
Select Audio INTERNAL MICROPHONE EXTERNAL AUDIO
 MIX BOTH

H.264 Main

H.264 Profiles Baseline
H.264 Resolution 1920x1080
H.264 Quality 30 [10~51]
H.264 GOP(IDR) 30 [1~240]
H.264 FPS 30fps
Bitrate Control VBR CBR CVBR
H.264 Bitrate 10Mbit

H.264 Sub

H.264 Sub Profiles Baseline
H.264 Sub Resolution 640x360
H.264 Sub Quality 30 [10~51]
H.264 Sub GOP(IDR) 30 [1~240]
H.264 Sub FPS 30fps
Bitrate Control VBR CBR CVBR
H.264 Sub Bitrate 2Mbit

M-JPEG

M-JPEG Resolution 1920x1080
M-JPEG Quality 30 [0~99]
M-JPEG FPS 30fps
Bitrate Control VBR CBR
M-JPEG Bitrate 20Mbit

Figure 39. The Video Information page

Max Resolution

It display the maximum size that can be streamed.

Max FPS

It display the maximum framerate that can be streamed.

It is changed by the Mode setting of "6.3.8. Output Set".

Output Mode

Display the current sensor output mode.

It is changed by the Mode setting of "6.3.8. Output Set".

Recording time

Set the recording time.

It can be select from 30sec / 1min / 3min / 5min.

The default setting is "3min".

If this setting is changed, the current recording will be stopped once, and a new recording file will be created.

Note: It is recommended to reformat the microSD card after changing this setting.

Please refer to "6.6.1.Info" for details.

RTSP Port

Configure the port of the RTSP protocol.

It can be set between 1 - 65535.

The default setting is "554".

Note: If this setting cannot be changed, the port to be changed may be used. In that case, try rebooting once before making any changes.

HTTP & ONVIF Port

Configure the port of the HTTP & ONVIF protocol.

It can be set between 1 - 65535.

The default setting is "80".

This setting will be reflected on reboot.

Note: The same number cannot be set for RTSP Port and HTTP & ONVIF Port.

Authenticate streaming

Switch ON / OFF of the authentication function for streaming.

The username and the password are the same as the authentication of the web setting page.

For the default setting of the username and the password, please refer to 6.1.How to access the setting page.

The default setting is "OFF".

Note: Set it to ON when using it while the camera can connect to the Internet.

Select Recording

Select recorded streaming of microSD card.

It can be selected from H.264 MAIN / H.264 SUB.

The default setting is "H.264 MAIN".

Timestamp Display

Switch ON / OFF of the Timestamp.

The default setting is "ON".

Mix Audio with Streaming & Recoding

Switch audio input ON / OFF.

The default setting is "ON".

Select Audio

Select the audio input mode from the following 3.

Table 15. Selectable items of Select Audio

1	INTERNAL MICROPHONE	Use the included microphone.
2	EXTERNAL AUDIO	Use external input.
3	MIX BOTH	Use both.

The default setting is "INTERNAL MICROPHONE".

H.264 Main

H.264 Profiles

H.264 Main Select compression profile for streaming.

It can be selected from Baseline / Main.

For the same bit rate, the Main Profile tends to have higher image quality.

However, please note that some playback devices may not support Main Profile.

The default setting is "Baseline".

If this setting is changed, the current recording will be stopped once, and a new recording file will be created.

H.264 Resolution

H.264 Main Selects the resolution size of the streaming.

Table 16. Selectable items of H.264 Resolution

H.264 Resolution
1920x1080
1280x720
800x600
704x480
704x400
640x480
640x360
320x240

The default setting is "1920x1080".

If this setting is changed, the current recording will be stopped once, and a new recording file will be created.

H.264 Quality

It is enable when the Bitrate Control described later is "VBR".

Set compression ratio.

It can be set between 10 - 51.

The smaller the value, the higher the quality, and the larger the value, the lower the quality.

The default setting is "30".

H.264 GOP (IDR)

H.264 Main Set compression GOP for streaming.

It can be set between 1 - 240.

The smaller the value, the lower the compression rate, but the faster the seek time.

The larger the value, the higher the compression rate, but the seek time will be slower.

The default setting is "30".

If this setting is changed, the current recording will be stopped once, and a new recording file will be created.

H.264 FPS

H.264 Main Set framerate for streaming.

Depending on the Frequency setting on the "6.3.8. Output Set", the items that can be selected will change.

List items that can be selected below.

Table 17. Selectable items of H.264 FPS

When Frequency is 60Hz	When Frequency is 50Hz
60fps(*1)	50fps(*1)
30fps	25fps
15fps	5fps
10fps	1fps
6fps	—
5fps	—
3fps	—
2fps	—
1fps	—

The default setting is "30fps" or "25fps".

If this setting is changed, the current recording will be stopped once, and a new recording file will be created.

*1 When the setting Mode of "6.3.8. Output Set" is "NORMAL 60fps (NORMAL 50fps)", this item will be displayed.

If this setting cannot be changed to "60fps (50fps)", Set H.264 Main Resolution to something other than "1920x1080".

Bitrate Control

H.264 Main Select compression method for streaming from the following 3 methods.

Table 18. Selectable items of Bitrate Control

1	VBR	<p>Variable Bitrate.</p> <p>Quality is constant, and bitrate is variable.</p> <p>Since the bit rate changes according to the subject, network bandwidth can be used efficiently.</p> <p>However, since the bandwidth used is not constant, it is difficult to design the network.</p>
2	CBR	<p>Constant Bitrate.</p> <p>Bitrate is constant, and quality is variable.</p> <p>Because the bandwidth used is constant, network design is easy.</p> <p>However, depending on the subject, the bandwidth may be wasted, or the image quality may be poor.</p>
3	CVBR	<p>Constant Variable Bitrate.</p> <p>In H.264, the data size is reduced by putting the difference data (P-frame) between the complete image data (I-frame).</p> <p>In CBR mode, to keep the constant bandwidth, the quality of next I-frame is degraded, when size of P-frame is increase. During this period, the quality will be extremely reduced.</p> <p>In CVBR mode, keep the next I-frame quality, even if the size of P-frame is increase. As a result, the bit rate increases, but the image quality improves.</p>

The default setting is "CBR".

H.264 Bitrate

H.264 Main Select the upper limit Bitrate of streaming from the following.

Table 19. Selectable items of H.264 Bitrate

H.264 Bitrate
20 Mbit
19 Mbit
18 Mbit
17 Mbit
16 Mbit
15 Mbit
14 Mbit
13 Mbit
12 Mbit
11 Mbit
10 Mbit
9 Mbit
8 Mbit
7 Mbit
6 Mbit
5 Mbit
4 Mbit
3 Mbit
2 Mbit
1 Mbit
512 Kbit
256 Kbit
128 Kbit

The higher the setting, the higher the quality, but the larger the data size is.
The default setting is "10Mbit".

H.264 Sub

H.264 Sub Profiles

H.264 Sub Select compression profile for streaming.

Details are the same as H.264 Profiles of H.264 Main.

The default setting is "Baseline".

H.264 Sub Resolution

H.264 Sub Selects the resolution size of the streaming.

Table 20. Selectable items of H.264 Sub Resolution

H.264 Sub Resolution
640x360
320x240

The default setting is "640x360".

H.264 Sub Quality

It is enable when the Bitrate Control described later is "VBR".

Details are the same as H.264 Quality of H.264 Main.

The default setting is "30".

H.264 Sub GOP (IDR)

H.264 Sub Set compression GOP for streaming.

Details are the same as H.264 GOP of H.264 Main.

The default setting is "30".

H.264 Sub FPS

H.264 Sub Set framerate for streaming.

Details are the same as H.264 FPS of H.264 Main.

The default setting is "30fps" or "25fps".

Bitrate Control

H.264 Sub Select compression method for streaming.

Details are the same as Bitrate Control of H.264 Main.

The default setting is "CBR".

H.264 Sub Bitrate

H.264 Sub Select the upper limit Bitrate of streaming.

Details are the same as H.264 Bitrate of H.264 Main.

The default setting is "2Mbit".

MJPEG

M-JPEG Resolution

The resolution size of MJPEG streaming is fixed "1920 x 1080".

M-JPEG Quality

It is enable when the Bitrate Control described later is "VBR".

Set compression quality.

It can be set between 0 - 99.

The smaller the value, the lower the quality, and the larger the value, the higher the quality.

The default setting is "50".

M-JPEG FPS

MJPEG Set framerate for streaming.

Details are the same as H.264 FPS of H.264 Main.

The default setting is "30fps" or "25fps".

Bitrate Control

MJPEG Select the compression quality specification method for streaming from the following 2 method.

Table 21. Selectable items of Bitrate Control

1	VBR	Variable Bitrate. Quality is constant, and bitrate is variable.
2	CBR	Constant Bitrate. Bitrate is constant, and quality is variable.

The default setting is "CBR".

M-JPEG Bitrate

MJPEG Select the upper limit Bitrate of streaming from the following.

Table 22. Selectable items of M-JPEG Bitrate

MJPG Bitrate
50 Mbit
45 Mbit
40 Mbit
35 Mbit
30 Mbit
25 Mbit
20 Mbit
19 Mbit
18 Mbit
17 Mbit
16 Mbit
15 Mbit
14 Mbit
13 Mbit
12 Mbit
11 Mbit
10 Mbit
9 Mbit
8 Mbit
7 Mbit
6 Mbit
5 Mbit
4 Mbit
3 Mbit
2 Mbit
1 Mbit

The higher the setting, the higher the quality, but the larger the data size is.

The default setting is "20Mbit".

To update the setting value, please click "submit".

6.4.2. H.264 View

With the end of support for Internet Explorer, the function has been removed from F/W Ver.3.1.0.

6.4.3. JPEG View

Click “JPEG View” on menu to go to the view page.

Here you can watch image of JPEG.

JPEG images are updated instantly.

The image size will be fixed at 1920 x 1080.

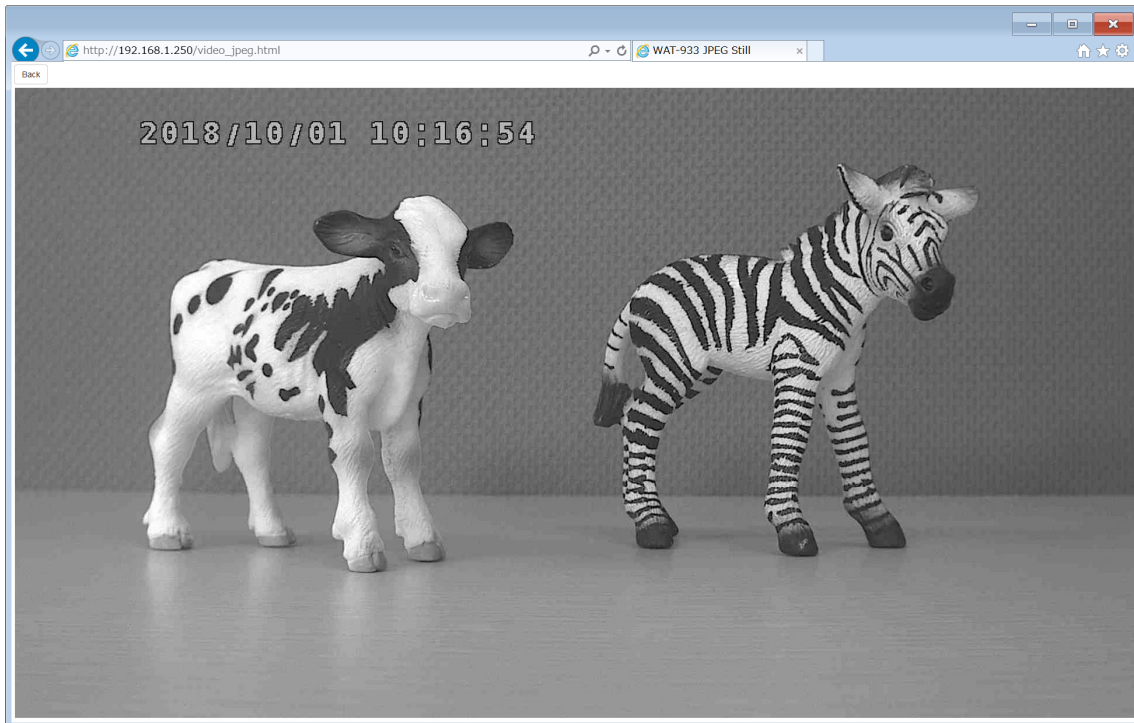

Figure 40. The JPEG view page

Back

Return the page to the previous page.

It is the same movement as the browser's back button.

6.5. NETWORK SETUP

6.5.1. Ethernet

Click “Ethernet” on menu to go to the Network Information page.

Here you can set network etc.

SYSTEM SETUP

- User
- Date & Time
- Update
- Save/Load Settings
- Reset

IMAGE SETUP

- IRIS
- Exposure
- Backlight
- Color
- Picture
- Privacy
- Motion
- Output Set
- System

VIDEO SETUP

- Video
- JPEG View

NETWORK SETUP

- Ethernet

Network Information submit

IP Address

Subnet Mask

Default Gateway

Primary DNS Server

Secondary DNS Server

Use DHCP USE UNUSE

Ethernet MTU [64~1500]

Note: This setting changes will be reflected on reboot.

Broadcast Filter ON OFF

Caution: This function reduces security risks from external networks. Normally, use with ON.

Figure 41. The Network Information page

IP Address

It is enable when the Use DHCP Server described later is “UNUSE”.

Set the IP address.

The default setting is “192.168.1.250”.

Subnet Mask

It is enable when the Use DHCP Server described later is “UNUSE”.

Set the sub-net mask.

The default setting is “255.255.255. 0”.

Note: IP Address where all bits of the host part are 1 or 0 cannot be set.

If it is set, it will be invalid and will return to the before setting value.

Default Gateway

It is enable when the Use DHCP Server described later is "UNUSE".

Set the default gateway.

The default setting is "192.168.1.1".

Primary DNS Server

It is enable when the Use DHCP Server described later is "UNUSE".

Configure the primary DNS server.

The default setting is "8.8.8.8".

Secondary DNS Server

It is enable when the Use DHCP Server described later is "UNUSE".

Configure the secondary DNS server.

The default setting is "8.8.4.4".

Use DHCP Server

Switch ON / OFF use of DHCP server.

When this setting is ON, this camera will receive the IP address from the external DHCP server.

The default setting is "OFF".

FTP Server

Switch ON / OFF FTP server function.

The default setting is "OFF".

For details on how to connect the FTP server, refer to "5.2. FTP Access" below.

Note: This function cannot be used with "6.6.1.Info Continuous Recording", "6.6.2.Schedule" or "6.6.3.Timelapse".

If this function cannot be enabled, please confirm that the above 3 functions are OFF.

Ethernet MTU

Set the Ethernet MTU.

This setting will be reflected on reboot.

The default setting is "1500".

Broadcast Filter

Function to ignore specific broadcast and multicast packets from external networks.

If you cannot access the camera from a network outside the router, you may be able to access it by setting it to OFF.

The default setting is "ON".

Caution: If this setting value is set to OFF, security risks may increase.

If you turn it OFF, please pay attention to security, such as setting "6.4.1.Video" Authenticate streaming to ON.

To update the setting value, please click "submit".

6.6. SD CARD SETUP

6.6.1. Info

Click “Info” on menu to go to the SD Card Information page.

Here you can make settings related to the microSD card.

SD Card Information		submit
Total Size	237922MB	
Used Size	148159MB	
Free Size	89763MB	
Free Percentage	37%	
Continuous Recording	<input checked="" type="radio"/> ON <input type="radio"/> OFF	
- Operation when SD-Card is full	<input checked="" type="radio"/> Overwrite <input type="radio"/> Recording Stop	
Save Jpeg in SD-Card	<input type="button" value="submit"/>	
Format	<input type="button" value="Format"/>	
Video & Snapshot Files	<input type="button" value="Files"/>	

Figure 42. The SD Card Information page

Total Size

Displays the total size of the microSD card.

Used Size

Displays the used size of the microSD card.

Free Size

Display the free size of the microSD card.

Note: Total Size, Used Size, and Free Size will not be displayed correctly for 10 seconds after the camera is started. Please wait at least 10 seconds after the startup and reopen the page.

Free Percentage

Displays the Percentage of (Free size) / (total size).

Continuous Recording

Switch ON / OFF recording to the microSD card.

The default setting is "ON".

Note: This function cannot be used with 6.5.1.Ethernet FTP Server or 6.6.3.Timelapse.

If this function cannot be enabled, please confirm that the above 2 functions are OFF.

Operation When SD-Card is full

Set the operation when the "Free Percentage" on the microSD card falls below 5%.

When "Overwrite" is selected, the oldest record is automatically deleted and a new one is created.

When "Recording Stop" is selected, the "Continuous Recording" is set to "OFF" and stop recording.

The default setting is "Overwrite".

Save Jpeg in SD-Card

Save JPEG still images to the microSD card.

The still image is saved at the moment when you click the "submit" button.

Format

Format the microSD card.

When you click the "Format" button, the page switches and Format starts.

When Format ends, you are prompted to restart, click the "OK" button.

Please attention that saved data on the microSD card will be deleted.

Note: Be sure to format each time you insert a microSD card into this camera.

Video & Snapshot Files

Download recorded video and still images saved to the microSD card.

In order to use this function, you need to set Continuous Recording, FTP Server of "6.5.1.Ethernet", Schedule Enable of "6.6.2.Schedule", and Timelapse Enable of "6.6.3.Timelapse" to "OFF".

When you click the "Files" button, you can check the file to the microSD card.

To update the setting value, please click "submit".

6.6.2. Schedule

Click "Schedule" on the menu to go to the Record Schedule page.

Here you can make settings related to the Record Schedule.

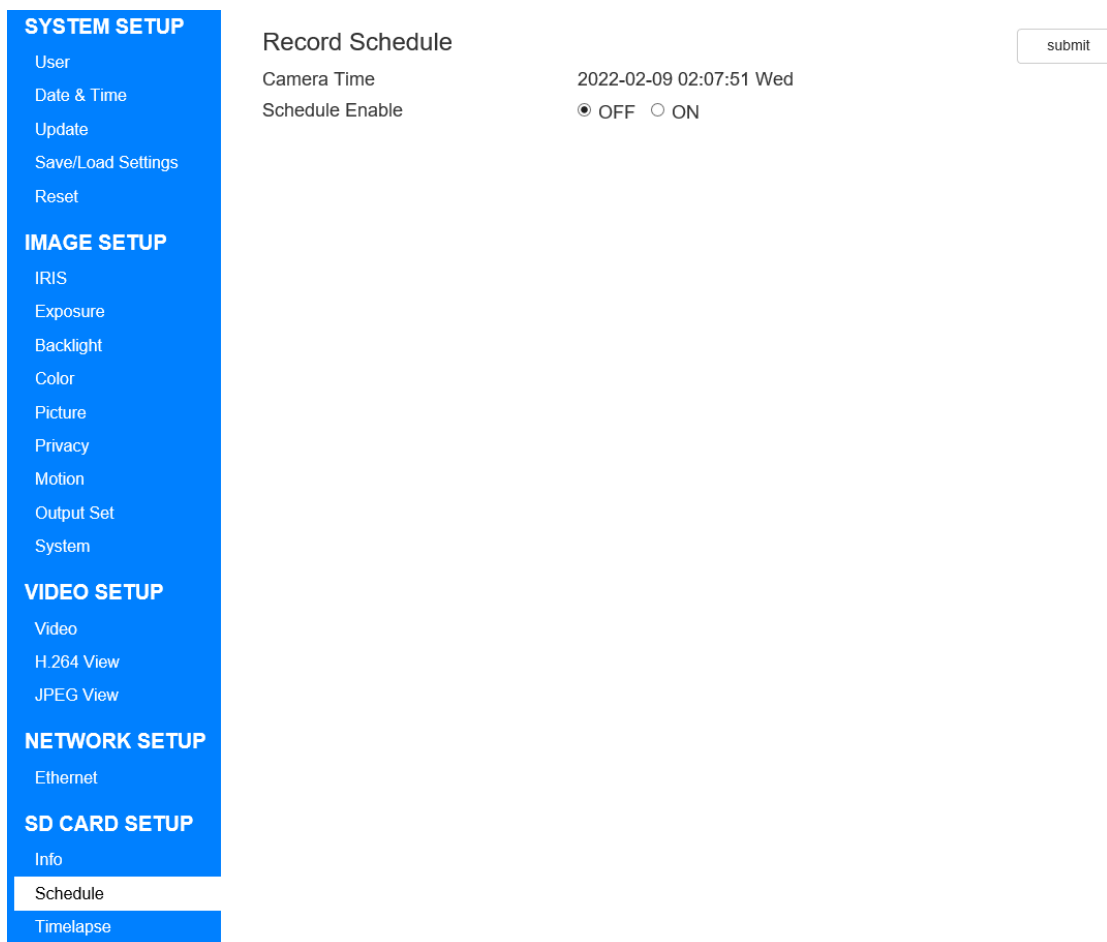

Figure 43. The Record Schedule page(When OFF)

Camera Time

Display the current time of the camera.

Schedule Enable

Switches the schedule function ON / OFF.

The default setting is "OFF".

When you select ON, detailed setting items will be displayed as shown below.

Note: In order to use this function, it is necessary to set the FTP Server of "6.5.1.Ethernet" and the Timelapse Enable of "6.6.3.Timelapse" to OFF.

SYSTEM SETUP

- User
- Date & Time
- Update
- Save/Load Settings
- Reset

IMAGE SETUP

- IRIS
- Exposure
- Backlight
- Color
- Picture
- Privacy
- Motion
- Output Set
- System

VIDEO SETUP

- Video
- H.264 View
- JPEG View

NETWORK SETUP

- Ethernet

SD CARD SETUP

- Info
- Schedule**
- Timelapse

Record Schedule

submit

Camera Time 2022-02-09 02:13:36 Wed
 Schedule Enable OFF ON

ALL	Mon	Tus	Wed	Thu	Fri	Sat	Sun
<input type="checkbox"/>	<input type="checkbox"/>	<input type="checkbox"/>	<input type="checkbox"/>	<input type="checkbox"/>	<input type="checkbox"/>	<input type="checkbox"/>	<input type="checkbox"/>
00:00~01:00 <input type="checkbox"/>	<input type="checkbox"/>	<input type="checkbox"/>	<input type="checkbox"/>	<input type="checkbox"/>	<input type="checkbox"/>	<input type="checkbox"/>	<input type="checkbox"/>
01:00~02:00 <input type="checkbox"/>	<input type="checkbox"/>	<input type="checkbox"/>	<input type="checkbox"/>	<input type="checkbox"/>	<input type="checkbox"/>	<input type="checkbox"/>	<input type="checkbox"/>
02:00~03:00 <input type="checkbox"/>	<input type="checkbox"/>	<input type="checkbox"/>	<input type="checkbox"/>	<input type="checkbox"/>	<input type="checkbox"/>	<input type="checkbox"/>	<input type="checkbox"/>
03:00~04:00 <input type="checkbox"/>	<input type="checkbox"/>	<input type="checkbox"/>	<input type="checkbox"/>	<input type="checkbox"/>	<input type="checkbox"/>	<input type="checkbox"/>	<input type="checkbox"/>
04:00~05:00 <input type="checkbox"/>	<input type="checkbox"/>	<input type="checkbox"/>	<input type="checkbox"/>	<input type="checkbox"/>	<input type="checkbox"/>	<input type="checkbox"/>	<input type="checkbox"/>
05:00~06:00 <input type="checkbox"/>	<input type="checkbox"/>	<input type="checkbox"/>	<input type="checkbox"/>	<input type="checkbox"/>	<input type="checkbox"/>	<input type="checkbox"/>	<input type="checkbox"/>
06:00~07:00 <input type="checkbox"/>	<input type="checkbox"/>	<input type="checkbox"/>	<input type="checkbox"/>	<input type="checkbox"/>	<input type="checkbox"/>	<input type="checkbox"/>	<input type="checkbox"/>
07:00~08:00 <input type="checkbox"/>	<input type="checkbox"/>	<input type="checkbox"/>	<input type="checkbox"/>	<input type="checkbox"/>	<input type="checkbox"/>	<input type="checkbox"/>	<input type="checkbox"/>
08:00~09:00 <input type="checkbox"/>	<input type="checkbox"/>	<input type="checkbox"/>	<input type="checkbox"/>	<input type="checkbox"/>	<input type="checkbox"/>	<input type="checkbox"/>	<input type="checkbox"/>
09:00~10:00 <input type="checkbox"/>	<input type="checkbox"/>	<input type="checkbox"/>	<input type="checkbox"/>	<input type="checkbox"/>	<input type="checkbox"/>	<input type="checkbox"/>	<input type="checkbox"/>
10:00~11:00 <input type="checkbox"/>	<input type="checkbox"/>	<input type="checkbox"/>	<input type="checkbox"/>	<input type="checkbox"/>	<input type="checkbox"/>	<input type="checkbox"/>	<input type="checkbox"/>
11:00~12:00 <input type="checkbox"/>	<input type="checkbox"/>	<input type="checkbox"/>	<input type="checkbox"/>	<input type="checkbox"/>	<input type="checkbox"/>	<input type="checkbox"/>	<input type="checkbox"/>
12:00~13:00 <input type="checkbox"/>	<input type="checkbox"/>	<input type="checkbox"/>	<input type="checkbox"/>	<input type="checkbox"/>	<input type="checkbox"/>	<input type="checkbox"/>	<input type="checkbox"/>
13:00~14:00 <input type="checkbox"/>	<input type="checkbox"/>	<input type="checkbox"/>	<input type="checkbox"/>	<input type="checkbox"/>	<input type="checkbox"/>	<input type="checkbox"/>	<input type="checkbox"/>
14:00~15:00 <input type="checkbox"/>	<input type="checkbox"/>	<input type="checkbox"/>	<input type="checkbox"/>	<input type="checkbox"/>	<input type="checkbox"/>	<input type="checkbox"/>	<input type="checkbox"/>
15:00~16:00 <input type="checkbox"/>	<input type="checkbox"/>	<input type="checkbox"/>	<input type="checkbox"/>	<input type="checkbox"/>	<input type="checkbox"/>	<input type="checkbox"/>	<input type="checkbox"/>
16:00~17:00 <input type="checkbox"/>	<input type="checkbox"/>	<input type="checkbox"/>	<input type="checkbox"/>	<input type="checkbox"/>	<input type="checkbox"/>	<input type="checkbox"/>	<input type="checkbox"/>
17:00~18:00 <input type="checkbox"/>	<input type="checkbox"/>	<input type="checkbox"/>	<input type="checkbox"/>	<input type="checkbox"/>	<input type="checkbox"/>	<input type="checkbox"/>	<input type="checkbox"/>
18:00~19:00 <input type="checkbox"/>	<input type="checkbox"/>	<input type="checkbox"/>	<input type="checkbox"/>	<input type="checkbox"/>	<input type="checkbox"/>	<input type="checkbox"/>	<input type="checkbox"/>
19:00~20:00 <input type="checkbox"/>	<input type="checkbox"/>	<input type="checkbox"/>	<input type="checkbox"/>	<input type="checkbox"/>	<input type="checkbox"/>	<input type="checkbox"/>	<input type="checkbox"/>
20:00~21:00 <input type="checkbox"/>	<input type="checkbox"/>	<input type="checkbox"/>	<input type="checkbox"/>	<input type="checkbox"/>	<input type="checkbox"/>	<input type="checkbox"/>	<input type="checkbox"/>
21:00~22:00 <input type="checkbox"/>	<input type="checkbox"/>	<input type="checkbox"/>	<input type="checkbox"/>	<input type="checkbox"/>	<input type="checkbox"/>	<input type="checkbox"/>	<input type="checkbox"/>
22:00~23:00 <input type="checkbox"/>	<input type="checkbox"/>	<input type="checkbox"/>	<input type="checkbox"/>	<input type="checkbox"/>	<input type="checkbox"/>	<input type="checkbox"/>	<input type="checkbox"/>
23:00~24:00 <input type="checkbox"/>	<input type="checkbox"/>	<input type="checkbox"/>	<input type="checkbox"/>	<input type="checkbox"/>	<input type="checkbox"/>	<input type="checkbox"/>	<input type="checkbox"/>

Figure 44. The Record Schedule page(When ON)

The schedule setting method is explained below.

A ALL <input type="checkbox"/>	Mon <input type="checkbox"/>	Tus <input type="checkbox"/>	Wed <input type="checkbox"/>	Thu <input type="checkbox"/>	Fri <input type="checkbox"/>	Sat <input type="checkbox"/>	Sun <input type="checkbox"/>
00:00~01:00 <input type="checkbox"/>	<input type="checkbox"/>	<input type="checkbox"/>	<input type="checkbox"/>	<input type="checkbox"/>	<input type="checkbox"/>	<input type="checkbox"/>	<input type="checkbox"/>
01:00~02:00 <input type="checkbox"/>	<input type="checkbox"/>	<input type="checkbox"/>	<input type="checkbox"/>	<input type="checkbox"/>	<input type="checkbox"/>	<input type="checkbox"/>	<input type="checkbox"/>
02:00~03:00 <input type="checkbox"/>	<input type="checkbox"/>	<input type="checkbox"/>	<input type="checkbox"/>	<input type="checkbox"/>	<input type="checkbox"/>	<input type="checkbox"/>	<input type="checkbox"/>
03:00~04:00 <input type="checkbox"/>	<input type="checkbox"/>	<input type="checkbox"/>	<input type="checkbox"/>	<input type="checkbox"/>	<input type="checkbox"/>	<input type="checkbox"/>	<input type="checkbox"/>
04:00~05:00 <input type="checkbox"/>	<input type="checkbox"/>	<input type="checkbox"/>	<input type="checkbox"/>	<input type="checkbox"/>	<input type="checkbox"/>	<input type="checkbox"/>	<input type="checkbox"/>
05:00~06:00 <input type="checkbox"/>	<input type="checkbox"/>	<input type="checkbox"/>	<input type="checkbox"/>	<input type="checkbox"/>	<input type="checkbox"/>	<input type="checkbox"/>	<input type="checkbox"/>
06:00~07:00 <input type="checkbox"/>	<input type="checkbox"/>	<input type="checkbox"/>	<input type="checkbox"/>	<input type="checkbox"/>	<input type="checkbox"/>	<input type="checkbox"/>	<input type="checkbox"/>
07:00~08:00 <input type="checkbox"/>	<input type="checkbox"/>	<input type="checkbox"/>	<input type="checkbox"/>	<input type="checkbox"/>	<input type="checkbox"/>	<input type="checkbox"/>	<input type="checkbox"/>
08:00~09:00 <input type="checkbox"/>	<input type="checkbox"/>	<input type="checkbox"/>	<input type="checkbox"/>	<input type="checkbox"/>	<input type="checkbox"/>	<input type="checkbox"/>	<input type="checkbox"/>
09:00~10:00 <input type="checkbox"/>	<input type="checkbox"/>	<input type="checkbox"/>	<input type="checkbox"/>	<input type="checkbox"/>	<input type="checkbox"/>	<input type="checkbox"/>	<input type="checkbox"/>
10:00~11:00 <input type="checkbox"/>	<input type="checkbox"/>	<input type="checkbox"/>	<input type="checkbox"/>	<input type="checkbox"/>	<input type="checkbox"/>	<input type="checkbox"/>	<input type="checkbox"/>
11:00~12:00 <input type="checkbox"/>	<input type="checkbox"/>	<input type="checkbox"/>	<input type="checkbox"/>	<input type="checkbox"/>	<input type="checkbox"/>	<input type="checkbox"/>	<input type="checkbox"/>
12:00~13:00 <input type="checkbox"/>	<input type="checkbox"/>	<input type="checkbox"/>	<input type="checkbox"/>	<input type="checkbox"/>	<input type="checkbox"/>	<input type="checkbox"/>	<input type="checkbox"/>
13:00~14:00 <input type="checkbox"/>	<input type="checkbox"/>	<input type="checkbox"/>	<input type="checkbox"/>	<input type="checkbox"/>	<input type="checkbox"/>	<input type="checkbox"/>	<input type="checkbox"/>
14:00~15:00 <input type="checkbox"/>	<input type="checkbox"/>	<input type="checkbox"/>	<input type="checkbox"/>	<input type="checkbox"/>	<input type="checkbox"/>	<input type="checkbox"/>	<input type="checkbox"/>
15:00~16:00 <input type="checkbox"/>	<input type="checkbox"/>	<input type="checkbox"/>	<input type="checkbox"/>	<input type="checkbox"/>	<input type="checkbox"/>	<input type="checkbox"/>	<input type="checkbox"/>
16:00~17:00 <input type="checkbox"/>	<input type="checkbox"/>	<input type="checkbox"/>	<input type="checkbox"/>	<input type="checkbox"/>	<input type="checkbox"/>	<input type="checkbox"/>	<input type="checkbox"/>
17:00~18:00 <input type="checkbox"/>	<input type="checkbox"/>	<input type="checkbox"/>	<input type="checkbox"/>	<input type="checkbox"/>	<input type="checkbox"/>	<input type="checkbox"/>	<input type="checkbox"/>
18:00~19:00 <input type="checkbox"/>	<input type="checkbox"/>	<input type="checkbox"/>	<input type="checkbox"/>	<input type="checkbox"/>	<input type="checkbox"/>	<input type="checkbox"/>	<input type="checkbox"/>
19:00~20:00 <input type="checkbox"/>	<input type="checkbox"/>	<input type="checkbox"/>	<input type="checkbox"/>	<input type="checkbox"/>	<input type="checkbox"/>	<input type="checkbox"/>	<input type="checkbox"/>
20:00~21:00 <input type="checkbox"/>	<input type="checkbox"/>	<input type="checkbox"/>	<input type="checkbox"/>	<input type="checkbox"/>	<input type="checkbox"/>	<input type="checkbox"/>	<input type="checkbox"/>
21:00~22:00 <input type="checkbox"/>	<input type="checkbox"/>	<input type="checkbox"/>	<input type="checkbox"/>	<input type="checkbox"/>	<input type="checkbox"/>	<input type="checkbox"/>	<input type="checkbox"/>
22:00~23:00 <input type="checkbox"/>	<input type="checkbox"/>	<input type="checkbox"/>	<input type="checkbox"/>	<input type="checkbox"/>	<input type="checkbox"/>	<input type="checkbox"/>	<input type="checkbox"/>
23:00~24:00 <input type="checkbox"/>	<input type="checkbox"/>	<input type="checkbox"/>	<input type="checkbox"/>	<input type="checkbox"/>	<input type="checkbox"/>	<input type="checkbox"/>	<input type="checkbox"/>

Figure 45. The Schedule select area

A) The All check

When this check is turned ON, all checks of B, C, and D are turned ON.

When this check is turned OFF, all checks of B, C, and D are turned OFF.

B) Checks of the timeframe

When the check in this area is turned ON, the check of the row in the same timeframe among the checks in the D area is turned ON.

When the check in this area is turned OFF, the check of the row in the same timeframe among the checks in the D area is turned OFF.

C) Checks of the day of the week

When the check in this area is turned ON, the check of the column in the same the day of the week among the checks in the D area is turned ON.

When the check in this area is turned OFF, the check of the column in the same the day of the week among the checks in the D area is turned OFF.

D) Checks of schedule

Switch the recording ON / OFF of the time frame for each day of the week.

Even if the check in areas A, B, and C is ON, if the check in this area is not ON, recording will not be performed.

Example:

When you want to record from 8 o'clock to 17 o'clock every day, set as follows.

ALL <input type="checkbox"/>	Mon <input type="checkbox"/>	Tus <input type="checkbox"/>	Wed <input type="checkbox"/>	Thu <input type="checkbox"/>	Fri <input type="checkbox"/>	Sat <input type="checkbox"/>	Sun <input type="checkbox"/>
00:00~01:00 <input type="checkbox"/>	<input type="checkbox"/>	<input type="checkbox"/>	<input type="checkbox"/>	<input type="checkbox"/>	<input type="checkbox"/>	<input type="checkbox"/>	<input type="checkbox"/>
01:00~02:00 <input type="checkbox"/>	<input type="checkbox"/>	<input type="checkbox"/>	<input type="checkbox"/>	<input type="checkbox"/>	<input type="checkbox"/>	<input type="checkbox"/>	<input type="checkbox"/>
02:00~03:00 <input type="checkbox"/>	<input type="checkbox"/>	<input type="checkbox"/>	<input type="checkbox"/>	<input type="checkbox"/>	<input type="checkbox"/>	<input type="checkbox"/>	<input type="checkbox"/>
03:00~04:00 <input type="checkbox"/>	<input type="checkbox"/>	<input type="checkbox"/>	<input type="checkbox"/>	<input type="checkbox"/>	<input type="checkbox"/>	<input type="checkbox"/>	<input type="checkbox"/>
04:00~05:00 <input type="checkbox"/>	<input type="checkbox"/>	<input type="checkbox"/>	<input type="checkbox"/>	<input type="checkbox"/>	<input type="checkbox"/>	<input type="checkbox"/>	<input type="checkbox"/>
05:00~06:00 <input type="checkbox"/>	<input type="checkbox"/>	<input type="checkbox"/>	<input type="checkbox"/>	<input type="checkbox"/>	<input type="checkbox"/>	<input type="checkbox"/>	<input type="checkbox"/>
06:00~07:00 <input type="checkbox"/>	<input type="checkbox"/>	<input type="checkbox"/>	<input type="checkbox"/>	<input type="checkbox"/>	<input type="checkbox"/>	<input type="checkbox"/>	<input type="checkbox"/>
07:00~08:00 <input type="checkbox"/>	<input type="checkbox"/>	<input type="checkbox"/>	<input type="checkbox"/>	<input type="checkbox"/>	<input type="checkbox"/>	<input type="checkbox"/>	<input type="checkbox"/>
08:00~09:00 <input type="checkbox"/>	<input checked="" type="checkbox"/>	<input checked="" type="checkbox"/>	<input checked="" type="checkbox"/>	<input checked="" type="checkbox"/>	<input checked="" type="checkbox"/>	<input checked="" type="checkbox"/>	<input checked="" type="checkbox"/>
09:00~10:00 <input type="checkbox"/>	<input checked="" type="checkbox"/>	<input checked="" type="checkbox"/>	<input checked="" type="checkbox"/>	<input checked="" type="checkbox"/>	<input checked="" type="checkbox"/>	<input checked="" type="checkbox"/>	<input checked="" type="checkbox"/>
10:00~11:00 <input type="checkbox"/>	<input checked="" type="checkbox"/>	<input checked="" type="checkbox"/>	<input checked="" type="checkbox"/>	<input checked="" type="checkbox"/>	<input checked="" type="checkbox"/>	<input checked="" type="checkbox"/>	<input checked="" type="checkbox"/>
11:00~12:00 <input type="checkbox"/>	<input checked="" type="checkbox"/>	<input checked="" type="checkbox"/>	<input checked="" type="checkbox"/>	<input checked="" type="checkbox"/>	<input checked="" type="checkbox"/>	<input checked="" type="checkbox"/>	<input checked="" type="checkbox"/>
12:00~13:00 <input type="checkbox"/>	<input checked="" type="checkbox"/>	<input checked="" type="checkbox"/>	<input checked="" type="checkbox"/>	<input checked="" type="checkbox"/>	<input checked="" type="checkbox"/>	<input checked="" type="checkbox"/>	<input checked="" type="checkbox"/>
13:00~14:00 <input type="checkbox"/>	<input checked="" type="checkbox"/>	<input checked="" type="checkbox"/>	<input checked="" type="checkbox"/>	<input checked="" type="checkbox"/>	<input checked="" type="checkbox"/>	<input checked="" type="checkbox"/>	<input checked="" type="checkbox"/>
14:00~15:00 <input type="checkbox"/>	<input checked="" type="checkbox"/>	<input checked="" type="checkbox"/>	<input checked="" type="checkbox"/>	<input checked="" type="checkbox"/>	<input checked="" type="checkbox"/>	<input checked="" type="checkbox"/>	<input checked="" type="checkbox"/>
15:00~16:00 <input type="checkbox"/>	<input checked="" type="checkbox"/>	<input checked="" type="checkbox"/>	<input checked="" type="checkbox"/>	<input checked="" type="checkbox"/>	<input checked="" type="checkbox"/>	<input checked="" type="checkbox"/>	<input checked="" type="checkbox"/>
16:00~17:00 <input type="checkbox"/>	<input checked="" type="checkbox"/>	<input checked="" type="checkbox"/>	<input checked="" type="checkbox"/>	<input checked="" type="checkbox"/>	<input checked="" type="checkbox"/>	<input checked="" type="checkbox"/>	<input checked="" type="checkbox"/>
17:00~18:00 <input type="checkbox"/>	<input type="checkbox"/>	<input type="checkbox"/>	<input type="checkbox"/>	<input type="checkbox"/>	<input type="checkbox"/>	<input type="checkbox"/>	<input type="checkbox"/>
18:00~19:00 <input type="checkbox"/>	<input type="checkbox"/>	<input type="checkbox"/>	<input type="checkbox"/>	<input type="checkbox"/>	<input type="checkbox"/>	<input type="checkbox"/>	<input type="checkbox"/>
19:00~20:00 <input type="checkbox"/>	<input type="checkbox"/>	<input type="checkbox"/>	<input type="checkbox"/>	<input type="checkbox"/>	<input type="checkbox"/>	<input type="checkbox"/>	<input type="checkbox"/>
20:00~21:00 <input type="checkbox"/>	<input type="checkbox"/>	<input type="checkbox"/>	<input type="checkbox"/>	<input type="checkbox"/>	<input type="checkbox"/>	<input type="checkbox"/>	<input type="checkbox"/>
21:00~22:00 <input type="checkbox"/>	<input type="checkbox"/>	<input type="checkbox"/>	<input type="checkbox"/>	<input type="checkbox"/>	<input type="checkbox"/>	<input type="checkbox"/>	<input type="checkbox"/>
22:00~23:00 <input type="checkbox"/>	<input type="checkbox"/>	<input type="checkbox"/>	<input type="checkbox"/>	<input type="checkbox"/>	<input type="checkbox"/>	<input type="checkbox"/>	<input type="checkbox"/>
23:00~24:00 <input type="checkbox"/>	<input type="checkbox"/>	<input type="checkbox"/>	<input type="checkbox"/>	<input type="checkbox"/>	<input type="checkbox"/>	<input type="checkbox"/>	<input type="checkbox"/>

Figure 46. Example of schedule setting

To update the setting value, please click “submit”.

6.6.3. Timelapse

Click “Timelapse” on the menu to go to the Timelapse page.

Here you can make settings related to the Timelapse.

The screenshot shows the 'Timelapse' configuration page. On the left is a blue sidebar menu with categories: SYSTEM SETUP, IMAGE SETUP, VIDEO SETUP, NETWORK SETUP, and SD CARD SETUP. The 'Timelapse' option is highlighted under SD CARD SETUP. The main content area has a title 'Timelapse' and a 'submit' button. Below the title, there are three settings: 'Camera Time' showing '2019-01-09 15:00:31', 'Timelapse Enable' with radio buttons for 'OFF' (selected) and 'ON', and 'Interval Time' with an input field containing '10' and a range indicator '[10 - 604800](sec)'.

Figure 47. The Timelapse page

Camera Time

Display the current time of the camera.

Timelapse Enable

Switch ON / OFF Timelapse function.

The default setting is “OFF”.

Image saving starts when it is set to ON, and image saving is performed each time the Interval Time elapses.

Note: In order to use this function, it is necessary to set the FTP Server of “6.5.1.Ethernet”, the Continuous Recording of “6.6.1.Info” or the Schedule Enable of “6.6.2.Schedule” to OFF.

Interval Time

Set the image save interval.

It can be set between 10 - 604800 sec.

The default setting is "10".

Note: The shooting interval is not necessarily the same as "Interval Time".

Depending on the situation of the system, the shooting interval may go long and short.

Note: About folder of Timelapse.

Files saved by the Timelapse function are saved in the "TIMELAPSEXXX" folder on the microSD card. (XXX is a sequential number.)

If the microSD card is formatted, TIMELAPSE000 will be created at camera startup.

In addition, the following folder is created for every 10000 files.

If created up to 999, the Timelapse function will stop working.

Also, if the folder name to be created is already in use, the Timelapse function will stop working.

Please format it. (Refer to Format of 6.6.1. Info.)

microSD card

- └ NORMAL (Folder for Video)
- └ SNAPSHOT (Folder for Snapshot)
- └ TIMELAPSE000 (Folder for Timelapse)
- └ TIMELAPSE001
- └ TIMELAPSE...

To update the setting value, please click "submit".

6.7. How to initialize the camera setting

You can use the microSD card to initialize the settings.

This initialization method can be used, for example, when you forget the ID / password required to login to the web setting page.

If you can login to the WEB setting page, initialization is possible with "6.2.5.Reset".

The procedure is described below.

- I. Mount the microSD card to be used to the PC.
- II. Format microSD card in Fat32.
- III. Create a file named "all_reset.bin" just under the drive of the microSD card.
Note: Please make it as a text file and make the file size 0 Byte.
All file names should be in lower case.
- IV. Unmount & Remove the microSD card from the PC.
- V. Power off this camera.
- VI. Mount the microSD card to this camera.
- VII. Power on this camera.
- VIII. Please wait for a while until it starts up. It will start in about 30 seconds.
- IX. When this camera is initialized correctly, "all_reset.bin" of the microSD card will be deleted. If initialization is not done, remount the microSD card to the PC and confirm that "all_reset.bin" has been deleted.
If "all_reset.bin" has not been deleted, please check the file name and file size again.

7. Reference

7.1. How to use ONVIF Device Manager

This camera conforms to the ONVIF Profile S.

Download the ONVIF Device Manager (ODM) from the following link;

<http://sourceforge.net/projects/onvifdm/>

Then install the ODM to your PC and initiate the ODM.



ODM starts as follows;

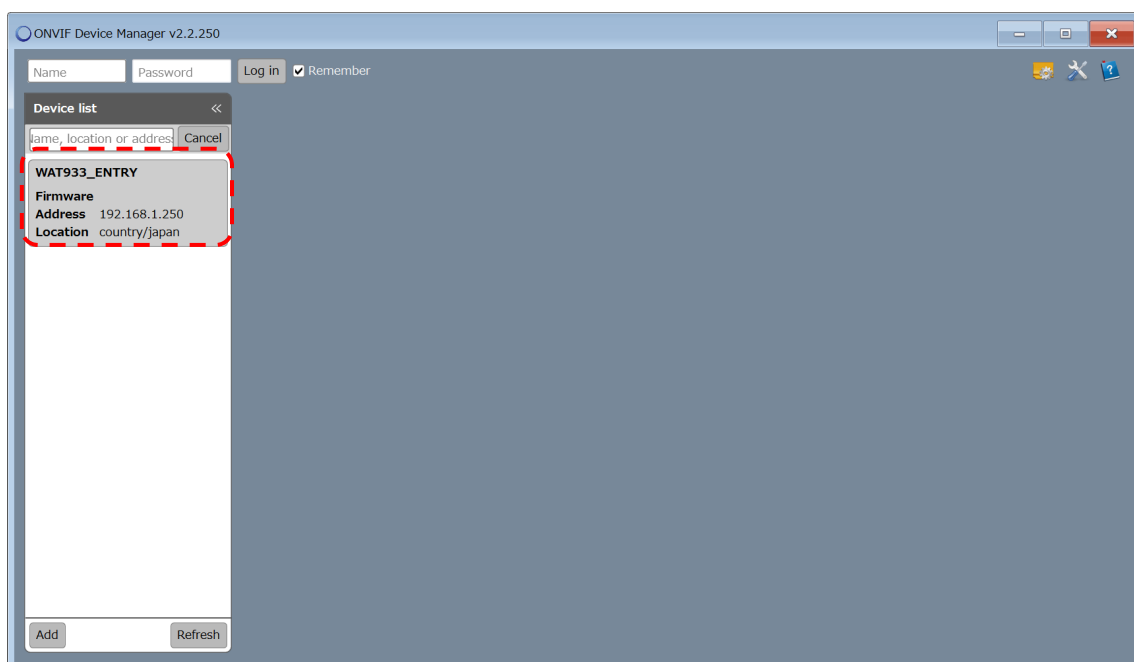

Figure 48. ODM screen

If the network configuration has been successfully connected without error, the WAT-933_ENTRY or WAT-2400S_ENTRY will show up in the Device list. Please make sure there is no error in the network settings if you do not see.

In the text box at the top of the screen, enter the ID and Password of the above-mentioned the User Information page in Name and Password respectively, and click "Log in".

When you have not changed, enter Name: root, Password: "Serial Number" & "Last two digits of MAC address".

Note: For F/W ver.2.0.9 or earlier, the password will be "1234".

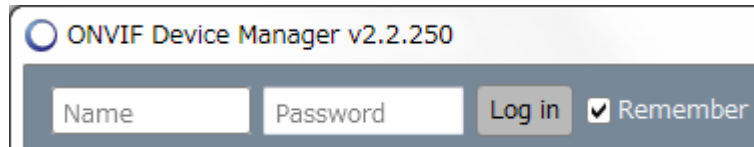

Figure 49. ODM Login

Once you have finished the login and click the "WAT-933_ENTRY" or "WAT-2400S_ENTRY" of the Device list. Since the menu is open, click "Live video". If there is not any problem, the moving image will be displayed as shown in the figure below.



Figure 50. Live video screen

In case of such as "Loading" is displayed and the image does not appear, please restart the ODM.

7.2. FTP Access

You can access internal storage by using FTP.

This section explains the connection method of using "FileZilla".

7.2.1. Enable the FTP server

The FTP Server function is off by default.

Before making an FTP connection, set the FTP server of "6.5.1. Ethernet" to ON.

Note: When switch ON of FTP server, you need to insert a microSD card.

Be sure to turn off the power of the camera before inserting or removing the microSD card.

7.2.2. A case of FileZilla

Download the appropriate Installer which meets your PC from FileZilla official download page (<https://filezilla-project.org/>) and install it.



Open the FileZilla when the installation is completed.

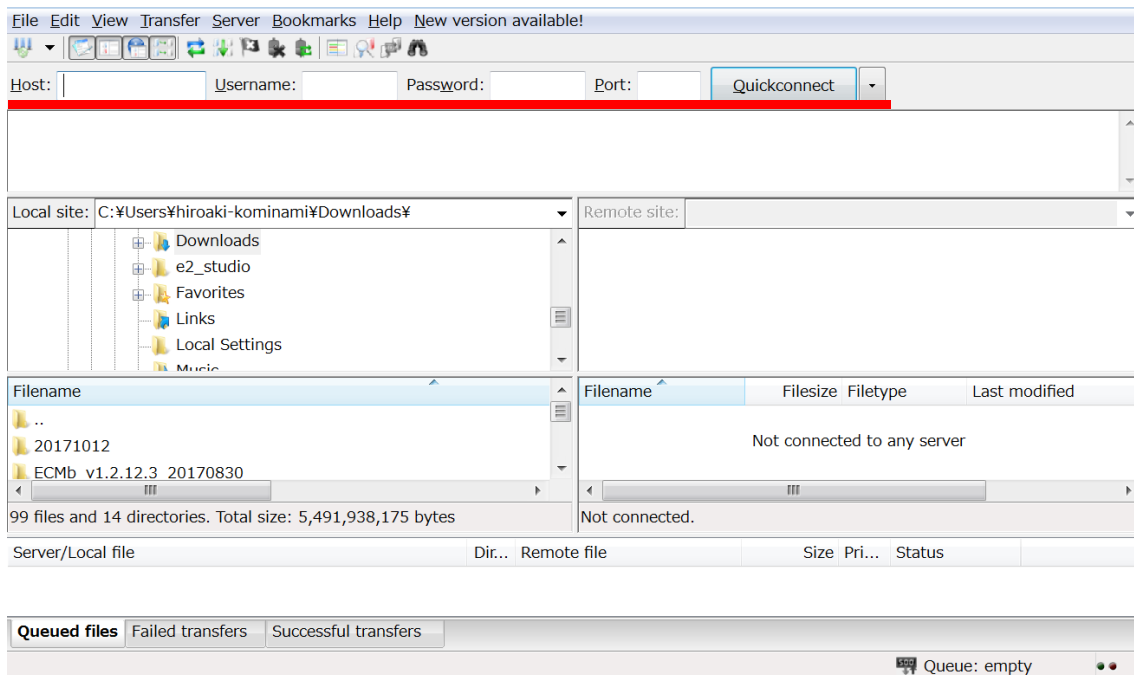

Figure 51. FileZilla screen

When this camera is the default setting, enter the following in the red line above.

Host: 192.168.1.250

Username: root

Password: "Serial Number" & "Last two digits of MAC address"

Port: (Blank)

Note: For F/W ver.2.0.9 or earlier, the password will be "1234".

Click "Quickconnect" to access internal storage.

Trademark Notice

Apple, iOS, and Safari are trademarks of Apple Inc., registered in the US and other countries.

Android, Chrome, Chromium, Google and Google Chrome are trademarks of Google LLC.

Linux is a trademark or registered trademark of Linus Torvalds in the United States and other countries.

Microsoft, Windows, Microsoft Edge, and Internet Explorer are trademarks or registered trademarks of Microsoft Corporation in the United States and other countries.

Mozilla and Firefox are trademarks or registered trademarks of Mozilla Foundation in the United States and other countries.

JavaScript is a trademark or registered trademark of Oracle Corporation and its subsidiaries and affiliates in the United States and other countries.

FileZilla is a trademark of the FileZilla project.

VideoLAN, VLC and VLC media player are trademarks of VideoLAN.

ONVIF is a registered trademark of ONVIF, Inc.

SD, microSD, SDHC and SDXC are trademarks or registered trademarks of the SD Card Association.

Other company names, product names, service names, etc. mentioned may be used as trademarks by each company.