

WAT-910HX

Operation Manual

This Operation Manual covers safety, camera functions, installation and the correct operating procedure for the WAT-910HX. First, we ask you to read this Operation Manual thoroughly, then install and operate the WAT-910HX as advised. In addition, for future reference, we also advise safekeeping of this manual.

Please contact the distributor or dealer from which the WAT-910HX was purchased, if you do not understand the installation, operation or safety instructions laid out in this manual. Not understanding the contents of the Operation Manual sufficiently may cause damage to the camera.

Guide to the Safety Symbols

The definitions of the symbols used in this operation manual are:

Danger When you do not adhere to or take notice of the "Danger" sign, it may lead to a serious accident such as death or injury caused by fire or electric shock.

Warning When you do not adhere to or take notice of the "Warning" sign, it may cause severe damage such as a physical injury.

Caution When you do not adhere to or take notice of the "Caution" sign, it may incur injury and cause damage to peripheral objects in the immediate surroundings.

Cautions for Safety

The WAT-910HX is designed to be used safely; however, if not used safely, it may lead to a physical accident caused by fire and electric shock. Therefore, please keep and read the "Cautions for safety" below for protection against accidents.

Do not disassemble and/or modify the WAT-910HX.
Do not operate the WAT-910HX with wet hands.

Use a stabilized power adaptor designed for DC+12V±10%, with a current capacity of more than 250mA for the WAT-910HX.

The recommended voltage is DC+12V±10%

Do not expose the WAT-910HX to wetness or high moisture conditions.

The WAT-910HX is designed and approved for indoor use only. The WAT-910HX is not water-resistant or waterproof. If the location of the camera is outdoors or in an outdoor like environment, we recommend that you use an outdoor camera housing.

Protect the WAT-910HX from condensation.

Keep the WAT-910HX dry at all times during storage and operation.

Should the camera not work properly, switch off the power immediately. Then check the camera according to the "Problems and Trouble shooting" section.

Avoid the striking of hard objects or dropping the WAT-910HX.

The WAT-910HX uses high quality electrical parts and precision components.

Do not connect any power supply directly to the video out terminal of the unit.

Do not connect the WAT-910HX with any monitor using a video/power single transmission terminal. The WAT-910HX is not designed for use with this type of equipment. We also advise you to read the operation manual of the monitor you plan to use before any connections are made.

Do not install the WAT-910HX in a position subject to direct sunlight.

Sunlight shining directly onto the WAT-910HX lens can cause damage to the CCD.

Select a stable place for installation of the WAT-910HX.

Use a support of durable strength around an installation position on a ceiling or wall when a camera stand or tripod is used.

Do not move the WAT-910HX with the cables connected.

Before moving the WAT-910HX, always remove the video cable and power cable from the rear of the camera first.

Avoid using the WAT-910HX near any strong electro-magnetic field.

After installing into main equipment, if the WAT-910HX is exposed to electromagnetic waves causing the monitored image to become distorted, we recommend the camera be shielded by appropriate protective casing.

Problems and Trouble Shooting

If any of the following problems occur when using the WAT-910HX,

- An optimal picture cannot be obtained, after checking that all the cables and connections are correctly in place
- Smoke or any unusual odor emerges from the WAT-910HX
- An object becomes embedded or a quantity of liquid seeps into the camera housing
- More than the recommended voltage or/and amperage has been applied to the WAT-910HX by mistake
- Anything unusual occurring to any equipment connected to the WAT-910HX

Disconnect the camera immediately according to the following procedures:

- Switch off the main power supply to the camera.
- Remove the power and video cables connected to the WAT-910HX.
- Contact the distributor or dealer from which the WAT-910HX was purchased.

About EMC

The WAT-910HX is in conformity with EMC test standards carried out by authorized organizations in Japan.

E I A FCC Part15 class B

CCIR EN61000-6-3/EN50130-4

Please use an auxiliary power supply (eg: UPS) to this camera to comply with EN50130-4 of EMC standards.

Do not modify the WAT-910HX. A modified camera may not conform to EMC test standards.

Contents

Using the contents figures below, check to make sure all parts are present before use.

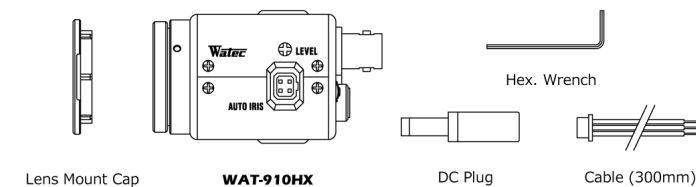

Description of Parts

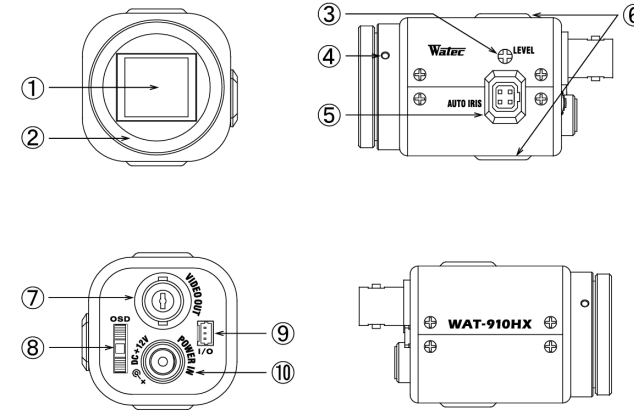

①IMAGE SENSOR FRONT FACE

- The light receiving face of the image sensor

(Dirt, water or oil deposits on the image sensor will cause an unclear picture on the monitor. Attach the lens cap to protect the lens and the CCD from contamination and damage.)

②LENS MOUNT

- Mount for the lens (CS-mount)

③IRIS LEVEL VOLUME

- By controlling the volume, the iris level of the DC iris lens can be adjusted.

④FINE FOCUS ADJUSTMENT SCREWS

- There are 3 hex. adjustment screws each placed at intervals of 120° for fine focusing of the lens.

⑤AUTO-IRIS SOCKET

- This socket is for the video/DC auto-iris lens cable connector. (Video/DC: Auto selected by the camera)

⑥TRIPOD MOUNTING SCREW HOLES

- Mounting holes for stands. The size of these threads are 1/4", 20 threads, 4.5±0.2mm, which is the same as any standard camera tripod (U1/4").

⑦VIDEO OUT (BNC)

- The terminal for composite video signal output

⑧OSD(On Screen Display) OPERATION DIAL

- The jog-dial for setting the functions on the screen.

⑨I/O CONNECTOR

- The control terminal for the Motion Detection.

⑩POWER IN

- The terminal designed for connection with the DC-plug of the power adaptor.

Power Supply

Use a stabilized power adaptor designed for DC+12V±10%, with a current capacity of more than 250mA. Use the optional DC plug if the shape or polarity of the DC plug of the power adaptor to be used is not compatible with the camera (See the drawing on the right below).

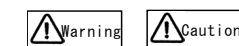

The wiring of the connector must be exact. Be careful not to touch the other terminal while wiring. Protect the wiring portion by using insulation tape after wiring. If the above care and attention is not adhered to, damage to the WAT-910HX and power adaptor may occur and may also cause fire.

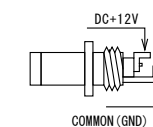

Auto-iris Lens

Before connecting the auto-iris lens, please make sure that the pin configuration is correct by confirming with the following table. If the configuration of your iris connector is different from the following, the plug and pins will need to be rewired.



Pin No.	EIAJ Video Auto-iris Lens Arrangement	EIAJ DC Auto-iris Lens Arrangement
①	Power	Control -
②	Not used	Control +
③	Iris signals	Drive +
④	Common (GND)	Drive -

Set-up and Operation

- Ensure that the power to the WAT-910HX and the peripheral equipment is turned off before making any connections.
- Remove the lens mount cap from the WAT-910HX and attach the CS-mount lens. Use the optional C-mount adaptor (30CMA-R) when a C-mount lens is used.
- Connect the iris control cable to ⑤AUTO-IRIS SOCKET on the WAT-910HX when an auto-iris lens is being used.
- Connect ⑦VIDEO OUT on the WAT-910HX with the monitor, using a coaxial cable with 75 impedance, such as an RG-59 or an RG-6/U.
※Select a monitor with the same television system as the WAT-910HX EIA or CCIR. A monitor with more than 600TV lines is recommended.
- Insert the power plug of the power adaptor into ⑩POWER IN on the back panel of the WAT-910HX. Confirm that the power adaptor is not connected to the power supply before insertion of the power plug into ⑩POWER IN.
- Turn on the power to the WAT-910HX, monitor and all other allied equipment. When a picture cannot be obtained on the monitor, or a problem occurs, check and follow the procedure mentioned in the 【Problems and Trouble Shooting】 section.
- After following the procedure below and the picture is still out of focus, open the iris fully and loosen ④FINE FOCUSING ADJUSTMENT SCREWS with the hex. wrench and move the lens forwards until a clear picture is obtained.

Manual Lens	Adjust the focus and iris to the best position on the lens.
Video Auto-iris Lens	Adjust the focus on the lens.
DC Auto-iris Lens	Adjust the iris level on the camera, then adjust the focus on the lens. See below.

Iris Level Adjustment (for DC auto-iris lenses only)

Adjust ③IRIS LEVEL VOLUME placed on the side of the unit until an acceptable light level is attained. No change will occur if a video iris lens or manual iris lens is fitted.

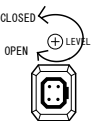

※When an auto iris lens is used, set SHUTTER to 1/60 (1/50), set SENS UP to OFF and set AGC to OFF by ⑧OSD OPERATION DIAL. Then adjust ③IRIS LEVEL VOLUME until an acceptable light level is attained.

8) When detailed settings are required or an adequate image is not obtained, set the functions on the screen by ⑧ OSD OPERATION DIAL.

9) When controlling the motion detection function, connect to ⑨ I/O CONNECTOR after wiring using the attached cable. See the pin configuration as follows.

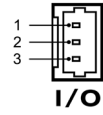

PIN No.	Cable color	Title	Function
1	Brown	MD_O	Alarm out
2	Black	GND	Camera GND
3	-	NC	

Alarm output terminal

When the motion detection function is used, the alarm output terminals 1 and 2 are hot during detection of movement in the monitored area. If an LED is connected as shown in the diagram below, the alert turns on the LED by voltage output of 3.3V at maximum current of 6mA.

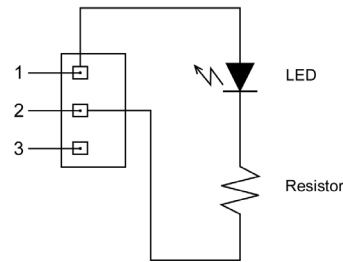

Contact information

- Design and specifications are subject to change without notice.
- Watec is not responsible for any inconvenience or the attendant damages to the video and monitoring recording equipment caused by misuse, mis-operation or improper wiring of our equipment.
- If for any reason the WAT-910HX does not work properly, or if you have any questions regarding installation or operation, please contact the distributor or dealer from which it was purchased.

※Minimum illumination specification applies to cameras with serial numbers from W154BE01001/W154BC01001 and higher.

Contact information

Watec Watec Co., Ltd.

Add.: 254-2 Nihonkoku, Daihoji, Tsuruoka- Shi,
Yamagata-Ken, 997-0017 Japan
TEL: +81-235-23-4400 FAX: +81-235-23-4409
E-mail: info-o@watec.co.jp
URL: http://www.watec.co.jp

1542Z00-Y2000003

Options

To purchase these options, please contact the distributor or dealer from which you purchased the WAT-910HX.



C-mount Adaptor (30CMA-R)

This lens mount adaptor is used to convert a CS-mount to a C-mount.



Mini Stand (MS50)

A convenient stand for the WAT-910HX. With this stand, the camera can be adjusted to any desired angle.